

Spinning Disk Confocal Microscope

**SpinDisk Series
Basic | Advance**



2023 V2

For customized projects please Contact us:

[**info@simtrum.com**](mailto:info@simtrum.com)

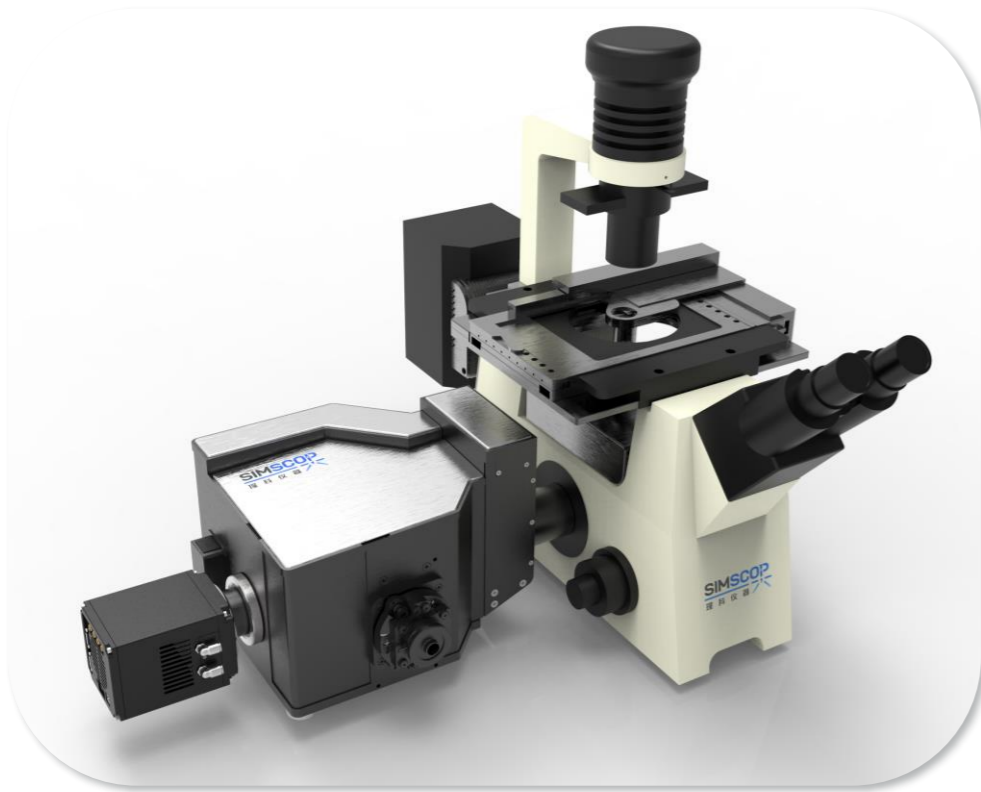

To guarantee each laboratory greater productivity without compromising the data quality, we have created the SpinDisk Basic, the most accessible spinning disk solution for fast and gentle confocal imaging.

The SpinDisk Basic combines high performance and flexibility. Offering customers the freedom to choose the turntable geometry that best suits their application (depth imaging, fast real-time imaging).

- Compatible with any upright or inverted microscope with a camera port.
- With the perfect match with pinhole size and high light throughput, the SpinDisk Basic can be coupled with LED and LASER light source.
- Custom-designed lenses are optimized to perform with a wide range of wavelengths from UV to near NIR to use a large variety of fluorophores

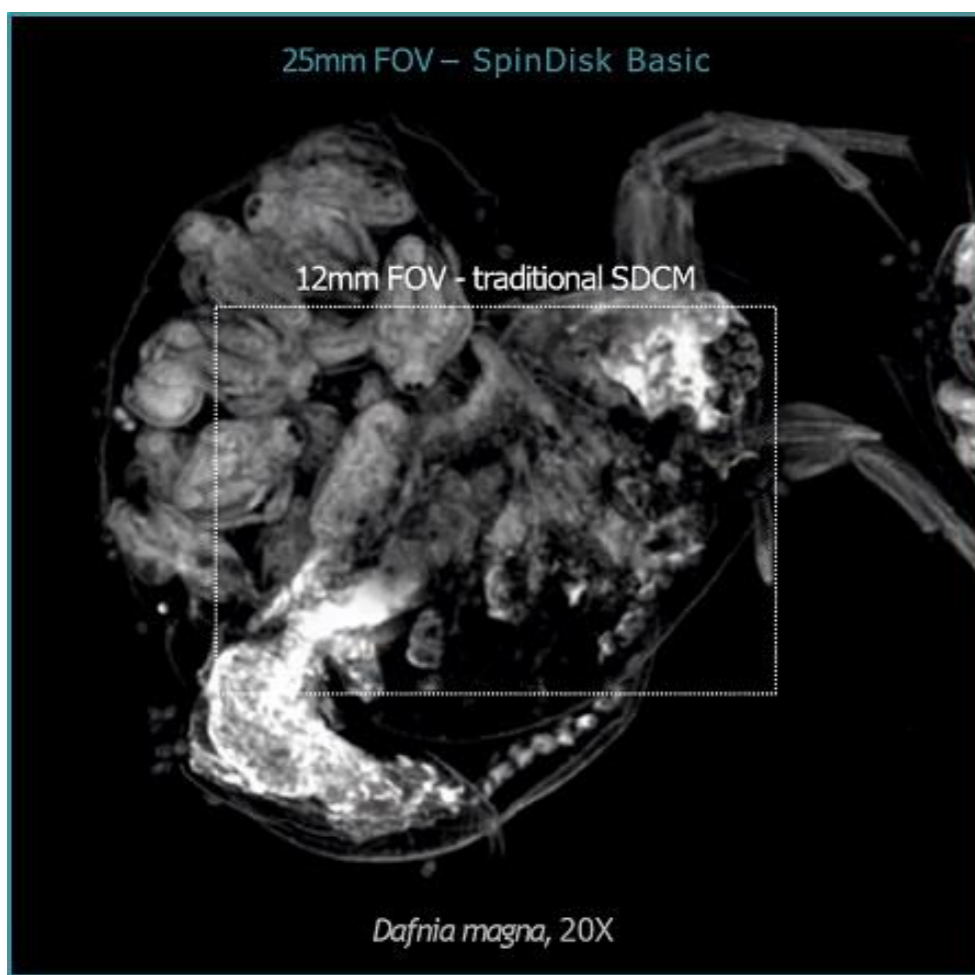

The wider FOV up to 25mm translates into more information collected and less tiles required to cover a large specimen

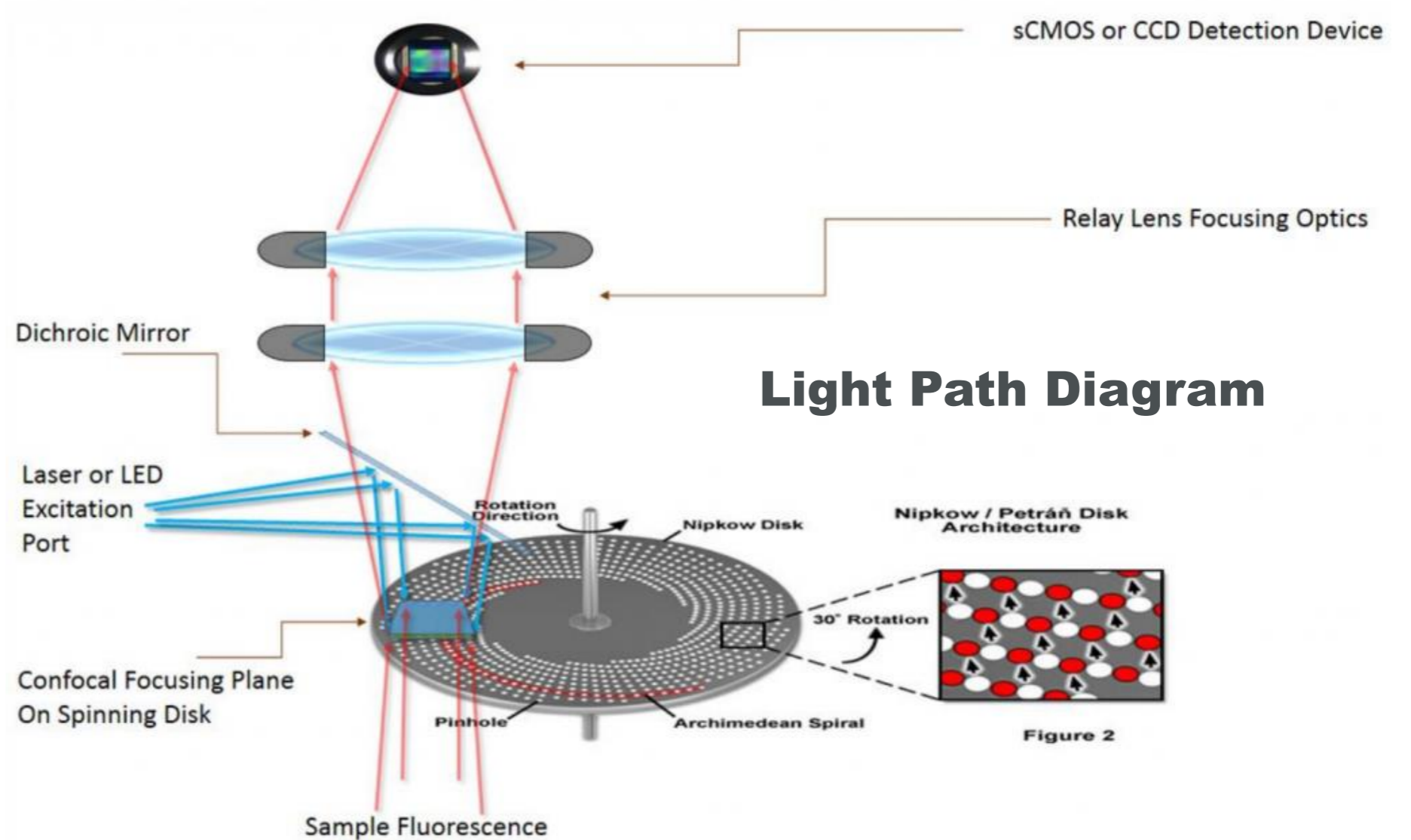

The SpinDisk Basic enables researchers to routinely perform challenging live-imaging experiments for extended periods of time. The highest spinning disk rotation on the market allows following ultra-fast cell.

The multi-beam spinning method offers not only high-speed imaging but significantly reduced photo bleaching and phototoxicity. This gentle illumination combined with advanced optical sectioning makes the SpinDisk Basic the standard tool for 3D live cell imaging.

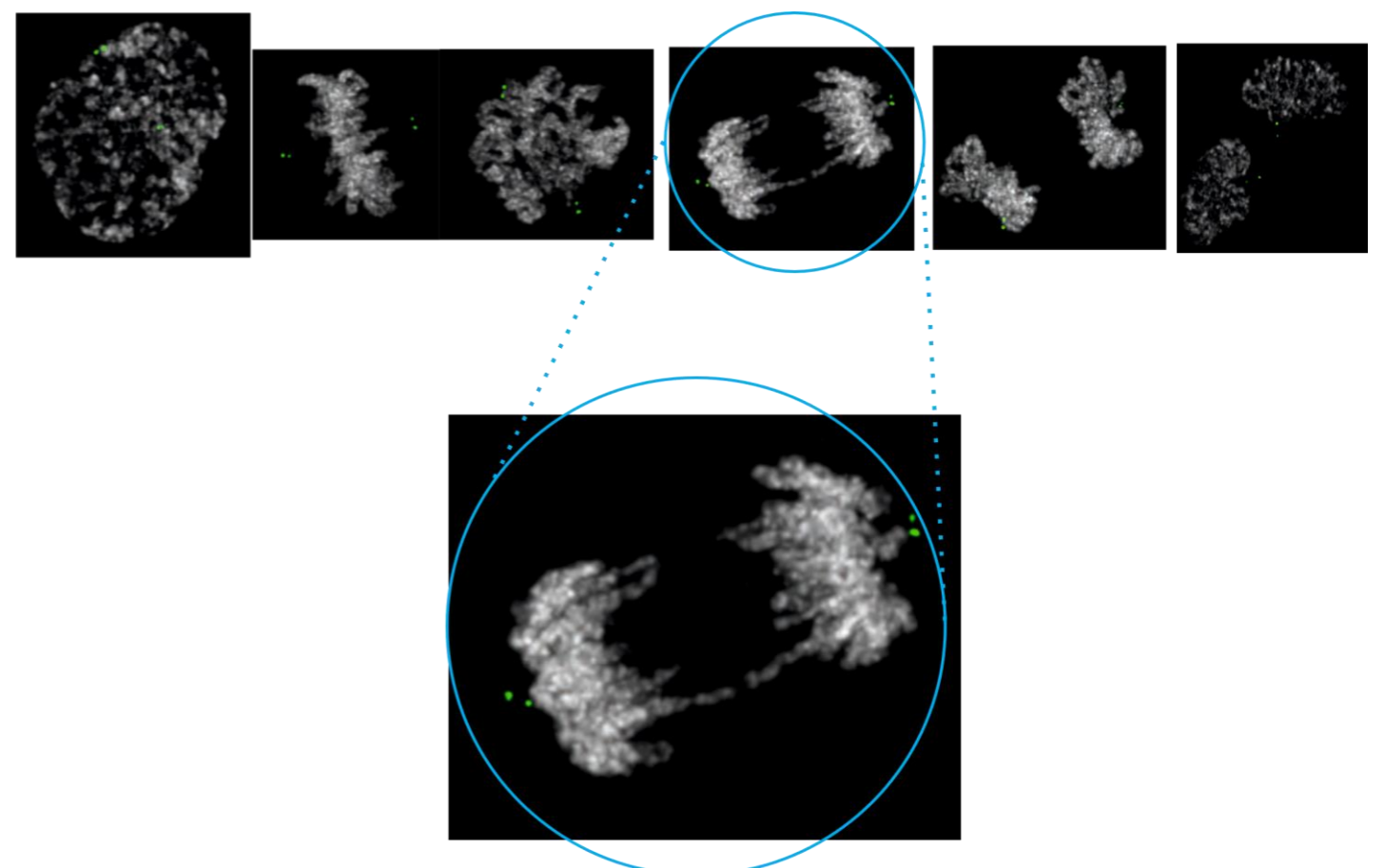
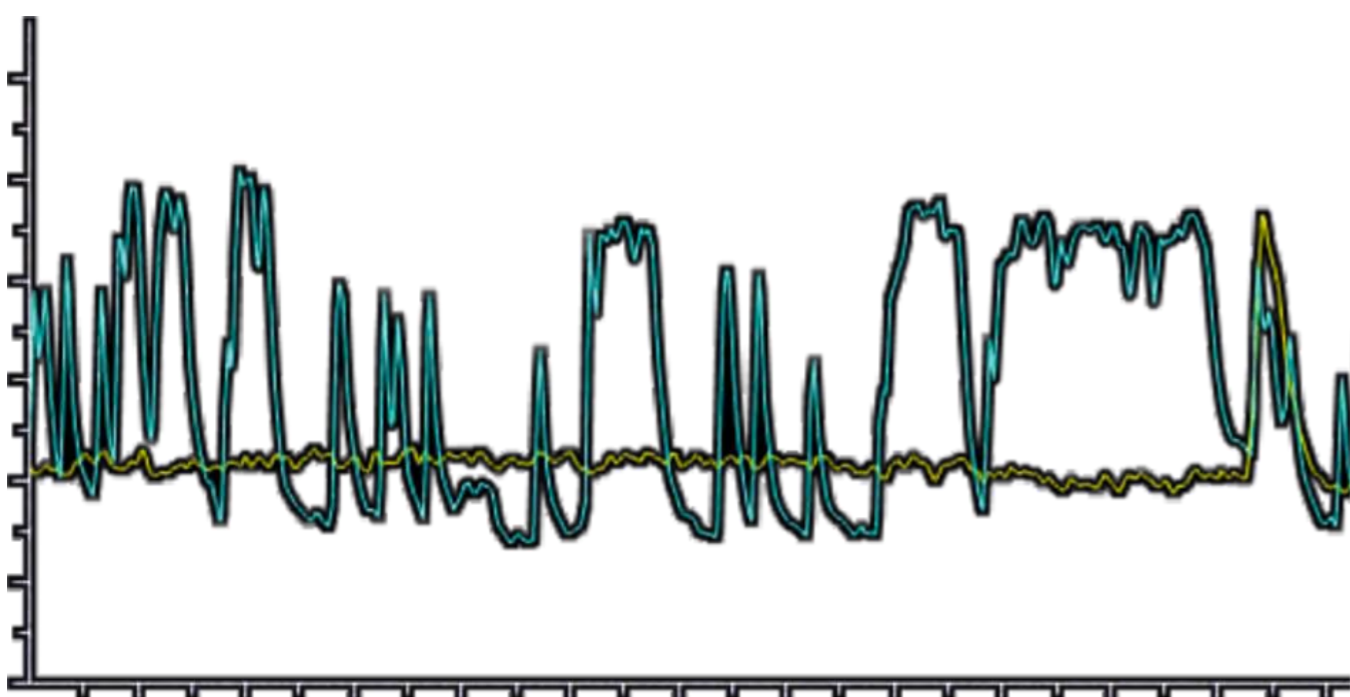

SpinDisk Advance is the next generation of spinning disk. It relies on the cutting-edge technology, advanced optical design and engineering solutions developed to meet the very high-end specifications required by modern fluorescence microscopy applications.

- **See Brighter – Enhanced Sensitivity and Image Quality**

The disk optimized geometry together with the carefully designed optical layout gives contrast and image clarity, ensuring brighter images of dim samples.

- **See Faster–High-sectioning, Hi-speed**

The capacity to image a field of view up to 25mm at the maximum disk rotation, makes the SpinDisk Advance the fastest confocal microscope on the market.

- **See More – Dual-camera, ultra-large field of view**

It is also the first confocal unit that allows dual camera imaging of the full field of view on both cameras with homogenous illumination.

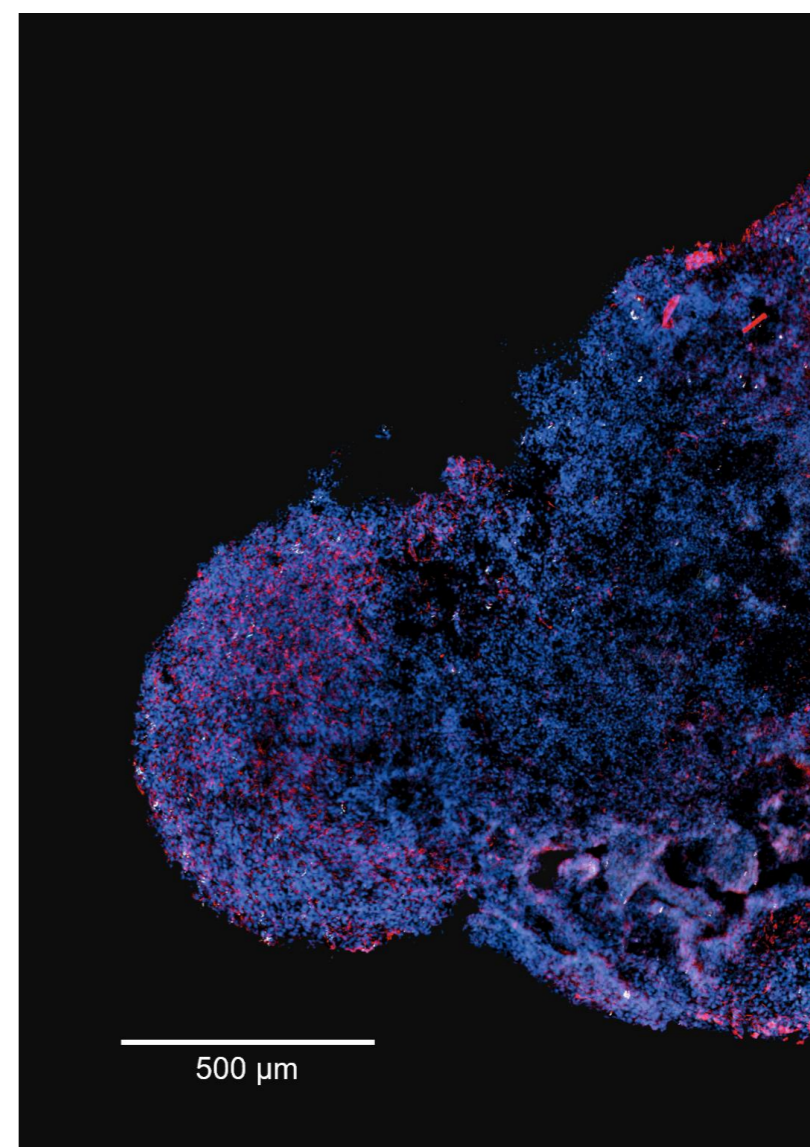

Day 50 human cerebral organoid showing CTIP2 – positive deep layer cortical neurons in white and pan-neuronal MAP2 marker signal in red. Nuclei were stained with DAPI(blue).

Optical Layout

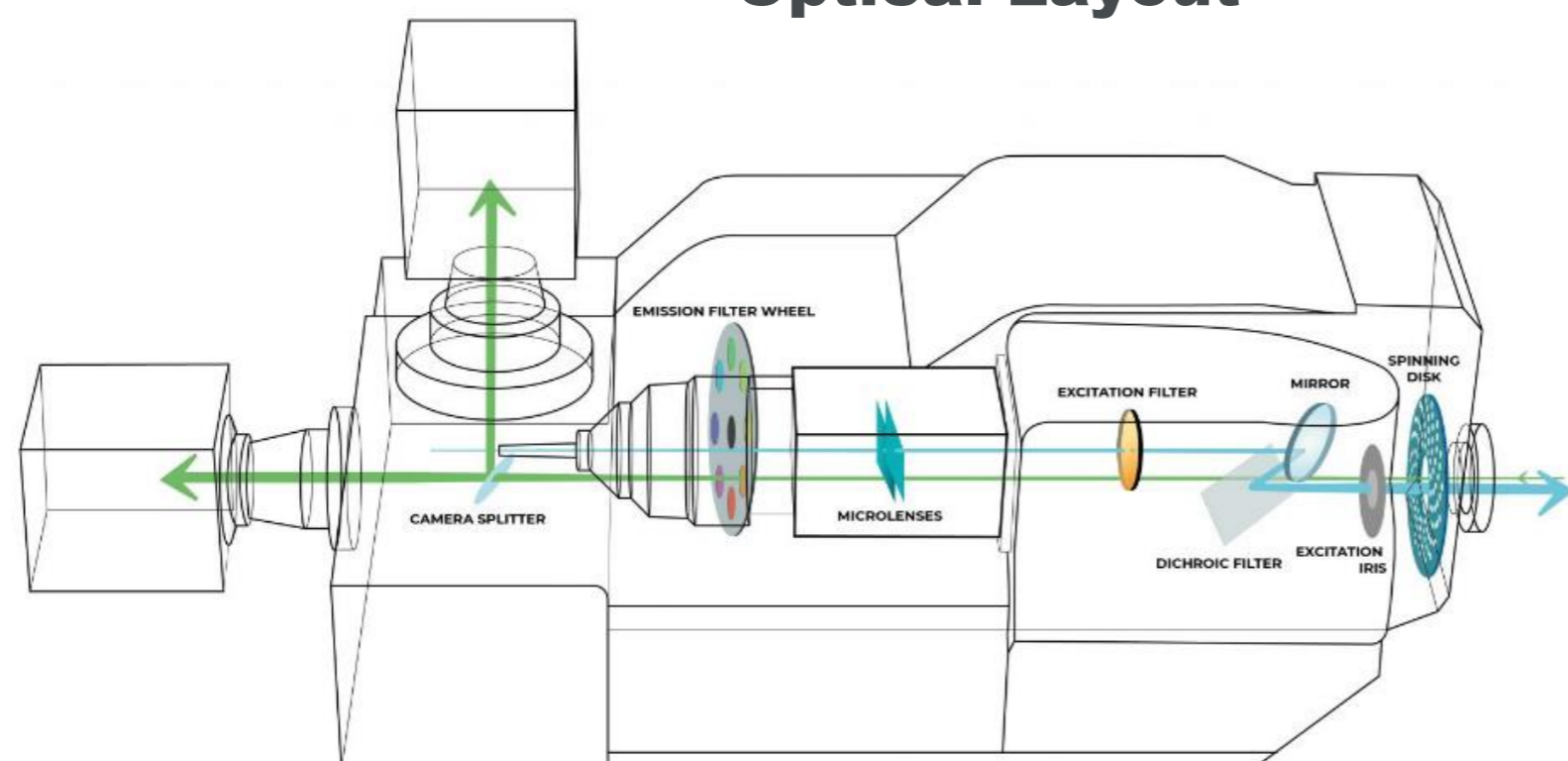

Multiple Modalities

The SpinDisk Advance is designed to be a truly enabling technology where performance is combined with the flexibility of a modular, expandable system. To achieve this, the SpinDisk Advance has three modes of use:

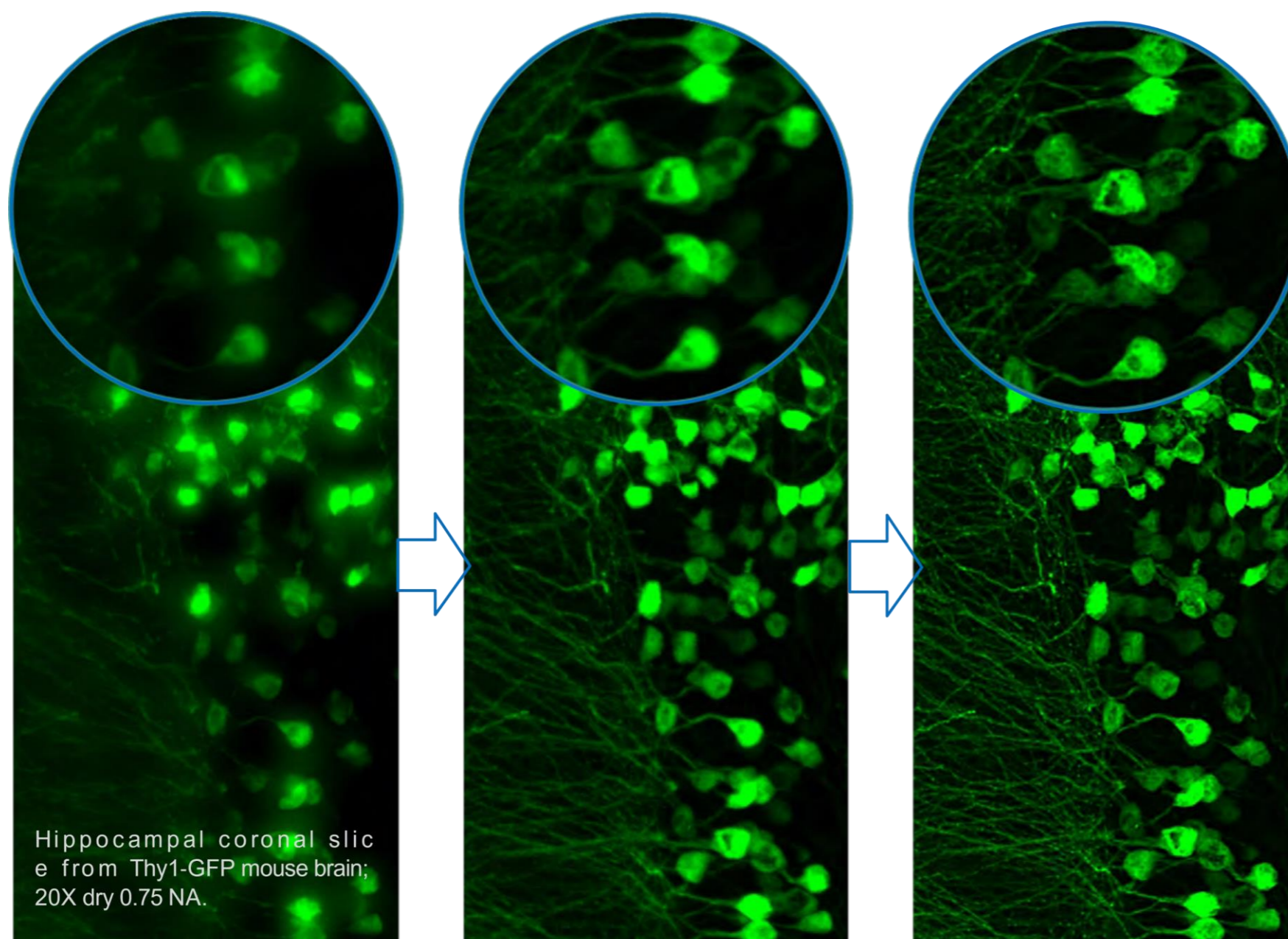

Left : The motorized IN / OUT disk allows for a fluid widefield/confocal transition without the need for realignment.(File at the bottom: Hippocampal coronal slice from Thy1-GFP mouse brain,20X dry 0.75 NA)

Middle : With the SpinDisk Advance, every upright or inverted microscope can benefit from confocal's advanced optical sectioning capacity

Left : The system is designed to be compatible with the SpinDisk SIM add-on , for a seamless evolution from confocal to super-resolution

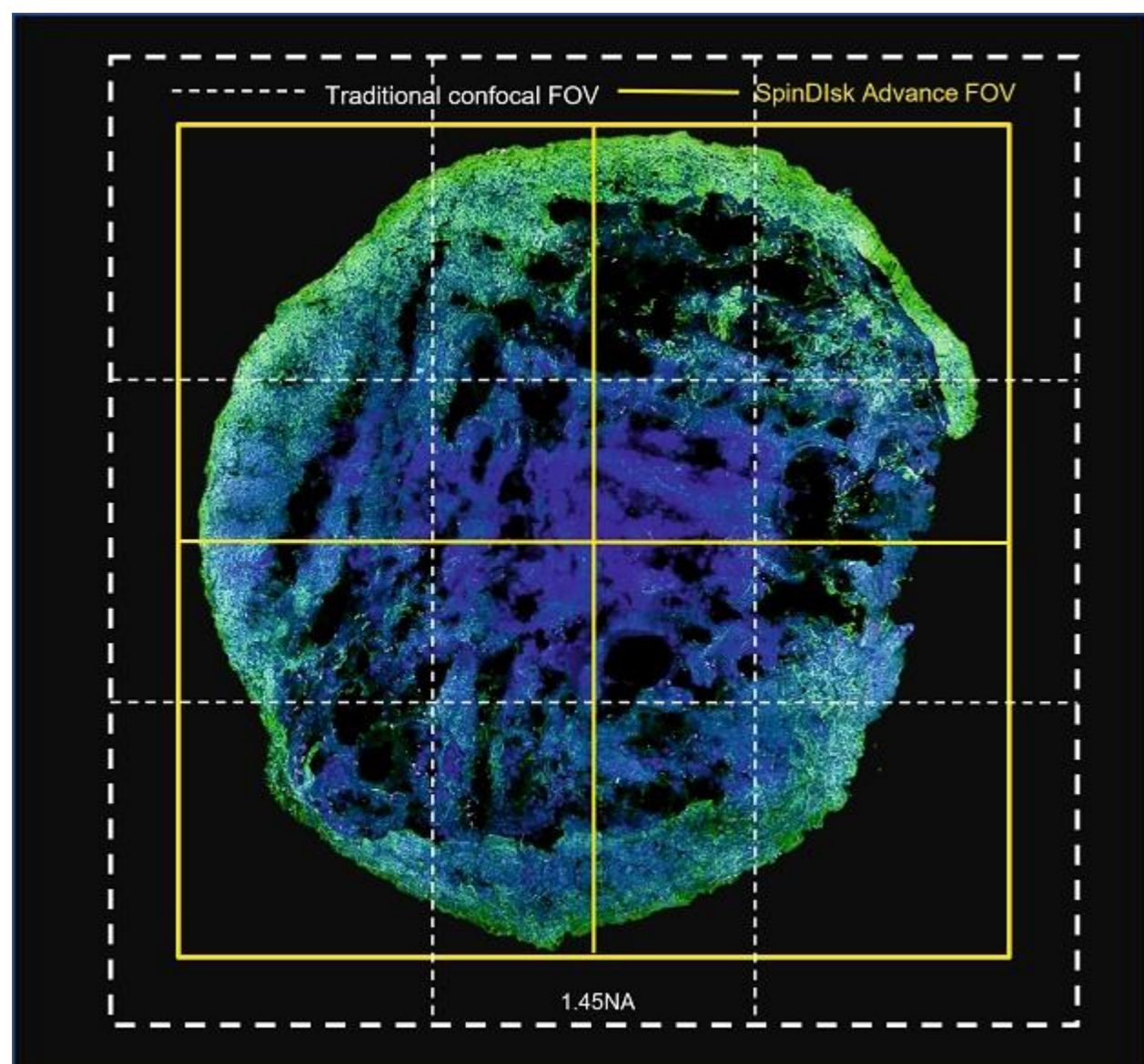

Largest FOV in The Market

The wider FOV allows the imaging of a sample area almost double the size of conventional imaging systems. A wider area translates into more information collected from each image and a reduction in the number of tiles needed to cover a large sample, significantly accelerating the research process. Further acceleration is provided by the dual-camera functionality.

Left image: Brain organoid, stitched image: Unclear transcription factor TBR1 (Alexa 750 fluorophore, shown in magenta), microtubule-associated protein MAP2 (Alexa 488 fluorophore, shown in green), DAPI for DNA in blue. Plan Apochromat Lambda 60X oil.

Uniform Illumination for Data Quantification

Homogeneous illumination over the entire field of view is essential for quantitative imaging. The SpinDisk Advance illuminator is based on micro-lens technology which is able to turn a high-power laser from a multi-mode fiber into a uniform square collimated beam with over 90% homogenous illumination over the entire 25mm FOV. This unique feature allows data quality and data throughput to be increased avoiding artifacts and recovering information even from the periphery.

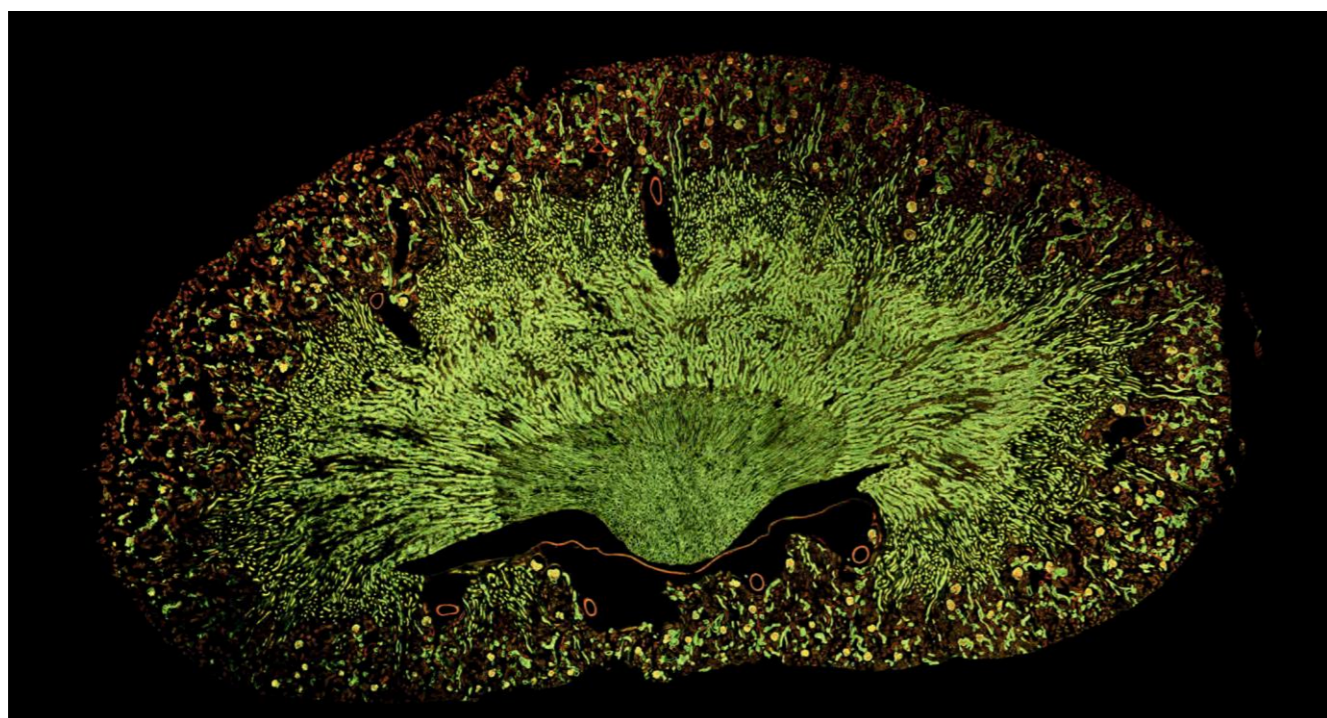
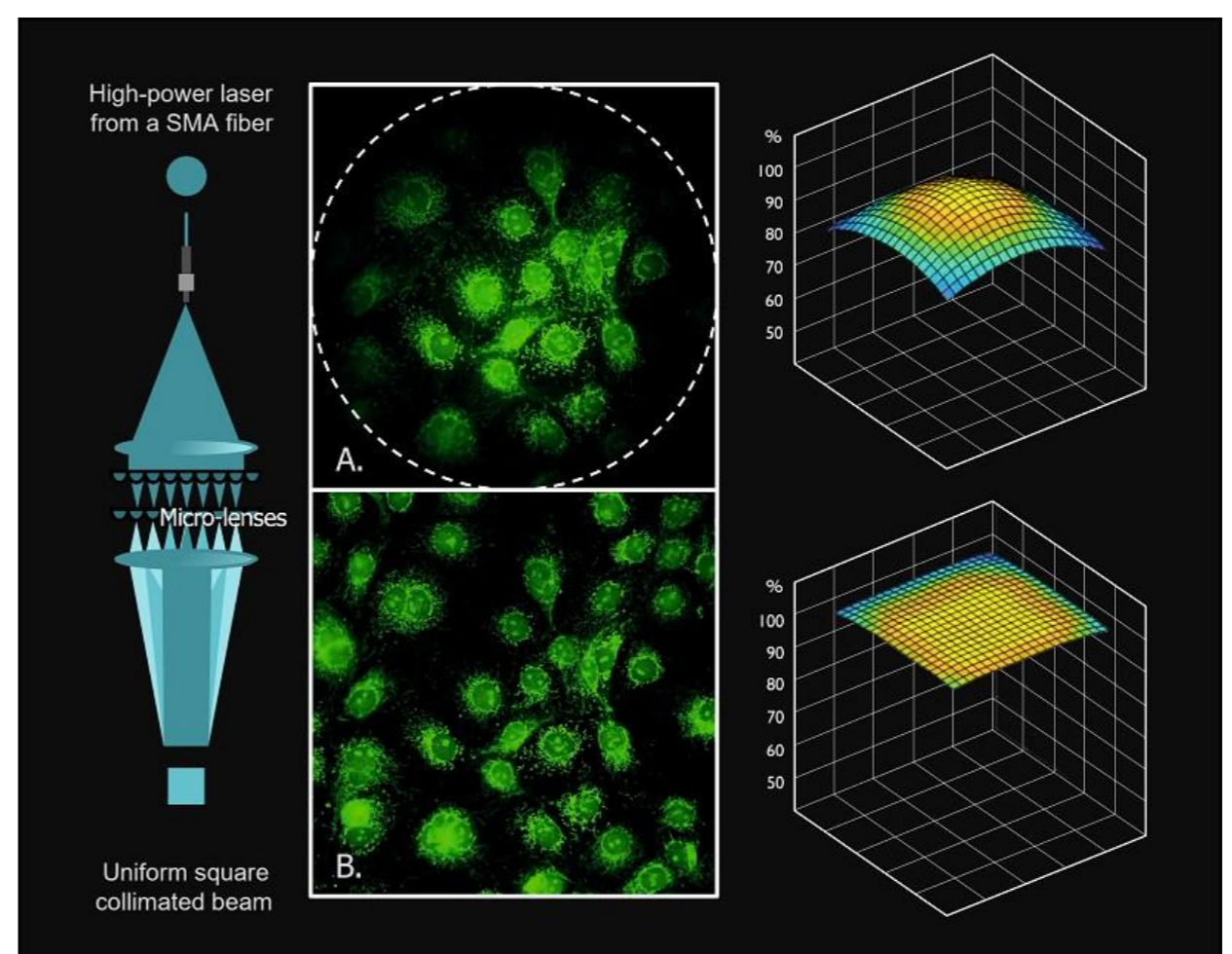

Seamless stitching of mouse kidney tissue section with Alexa 488 WGA, Alexa 568 Phalloidin

Seamless Stitching of Large Samples

Combined with the 25mm FOV, micro lenses are essential for seamless stitching of images of large samples like tissues, organoids and full organisms. This ability allows you to:

- Get reliable data without artifacts, avoiding any post-processing correction
- Reduce photobleaching and increase speed by minimizing the overlap of tiles
- Increase data throughput and guarantee data quality

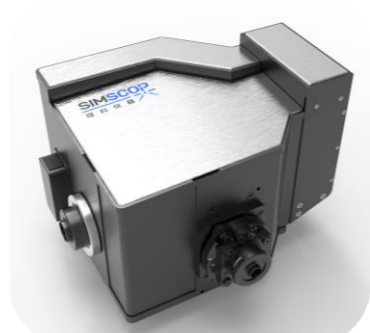

Parameters	SpinDisk Series - Basic	SpinDisk Series - Advance
Imaging Modalities	Widefield / Confocal / Fluorescence	Widefield / Confocal / Super-resolution (in combination with SIM Basic)
Compatible Microscopes	Full range of upright and inverted microscopes	Full range of upright and inverted microscopes
FOV	Up to 25mm diameter Plan apochromatic objectives 4x - 2.7mm x 2.7mm Plan apochromatic objectives 10x - 1.20mm x 1.20mm Plan apochromatic objectives 20x - 0.67mm x 0.67mm Plan apochromatic objectives 40x - 0.33mm x 0.33mm Plan apochromatic objectives 60x - 220µm x 220µm Plan apochromatic objectives 100x - 130µm x 130µm	
Laser	Multimode laser: 1.5mm SMA LED: 3mm LLG LED light source life >20,000 hours Power adjustment accuracy 1%	Multi model lasers with SMA coupling
Spectral Range	Excitation 365 -750 nm / Emission 400 - 850 nm / Excitation 400 - 1000nm	Excitation 400-750 nm / Emission 400-850 nm
Camera	sCMOS Camera, compatible with CCD/EMCCD camera	sCMOS camera, compatible with CCD/EMCCD camera Support dual-channel dual-camera imaging
Camera Index	Peak quantum efficiency 95% @600nm; Pixel size 6.5µm x 6.5µm; Resolution 2048x2048; Effective Area 13.3x13.3mm; Noise: 0.2e-; Full well capacitance: 45ke-; Compatible with air cooling/water cooling	
Disk Speed	15000 RPM	15000 RPM
Scan Rate	100 - 1000 fps	100 - 1000 fps
Spinning Disk Geometry (Diameter / Spacing)	50/250 slit for high throughput & live imaging applications 50/250 µm pinholes optimized for Laser light source 60/220 µm pinholes optimized for LED light source Customized geometry and dual pattern disks available on demand	50/250 slit spirals for high throughput applications 50/250 µm pinholes for routine imaging 50/400 µm with wider spacing for deep imaging
Resolution	Lateral Resolution (FWHM): ~230 nm (High NA 1.4) Axial Resolution (FWHM): ~600 nm (High NA 1.4)	Lateral Resolution (FWHM): ~230 nm (High NA 1.4) Axial Resolution (FWHM): ~600 nm (High NA 1.4)
Filter Wheels	8-position excitation filter wheel; 5-position dichroic filter wheel; 8-position emission filter wheel; Spindisk/Wide-field motorized switching	4-positions cleanup filter wheel, 3-positions dichroic filter wheel, 8-positions emission filter wheel, 3-position slider for dual camera
Filter Unit	DAPI EM 445nm/50nm GFP/ FITC EM 530nm/50nm DsRed / TRITC EM 605nm/60nm Cy5 EM 695nm/40nm	
Eyepiece	WF 10X/23 plan eyepiece, high eye point; centering telescope, 45° inclined, interpupillary distance adjustment 50–75mm, adjustable diopter	
Objective Converter	Converter with five-hole internal positioning; Ball bearing for internal positioning	
Stage	Manual: 240mm x 260mm fixed stage; Range of movement: 135mm x 85mm Motorized: Minimum step size: 50nm; Stroke: X:114mm Y:75mm; Repeatability: ±0.1µm; Maximum speed: ≥100mm/s; Stage size: ≥270x170mm Maximum load capacity > 1KG (Horizontal)	
Z Driver	Focusing resolution minimum step size: 0.05µm; Repeatability ±0.2µm; Maximum stroke: 10mm	
Focusing Mechanism	Coaxial coarse/ fine adjustment with limit and locking devices, Low level coaxial focusing handwheel; Handwheel graduations of fine adjustment: 1µm	
Software Feature	Multi-color fluorescence localization processing; Z-stack data processing; Large image stitching; Image analysis; Imaging data management; 3D imaging construction	
Recommended Installation Conditions	Temperature 23 ± 5°C, Humidity 70% RH or less (no condensation)	Temperature 23 ± 5°C, Humidity 70% RH or less (no condensation)
Weight	11.0 Kg (24.3 lbs)	26.0 Kg (57 lbs)
Size	11.2 (W) x 15.9 (L) x 8.9 (H) inches 286.7 (W) x 405.1 (L) x 226.5 (H) mm	14 (W) x 23.9 (L) x 8.9 (H) inches 357.0 (W) x 606.0 (L) x 225.0 (H) mm

Inverted

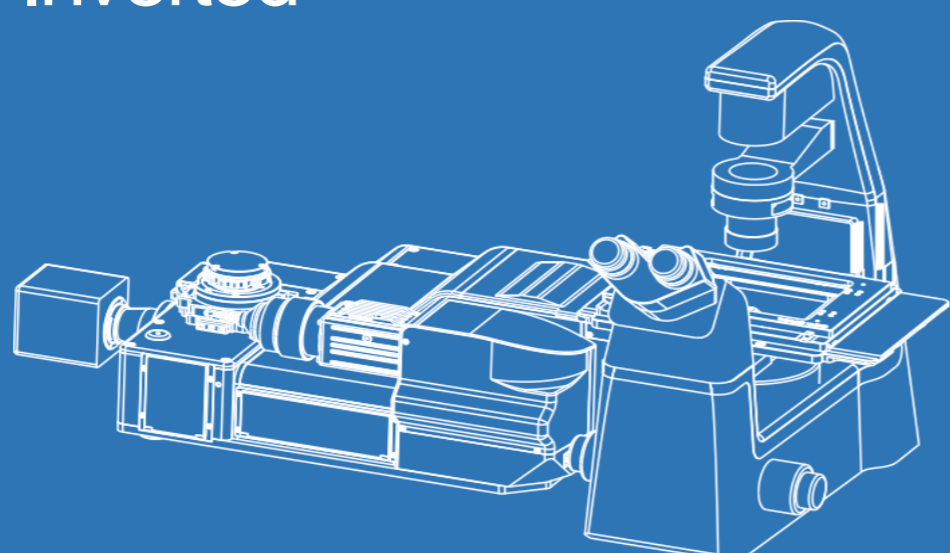

Upright

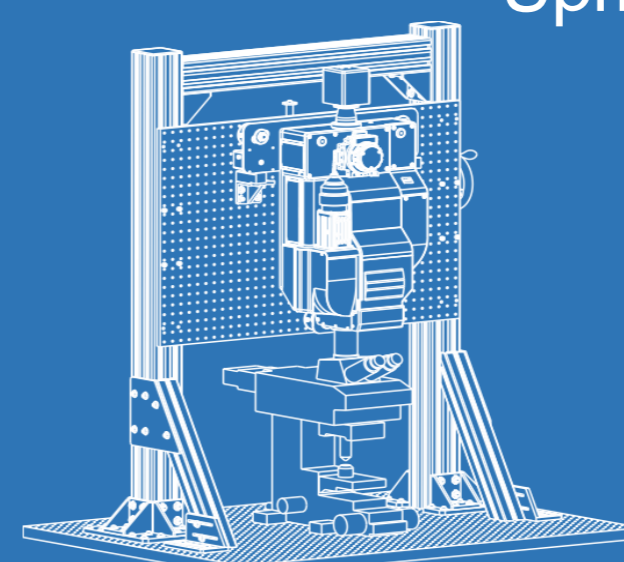

Software Surface

SIMSCOP CM Series Confocal Microscope Software Key Features

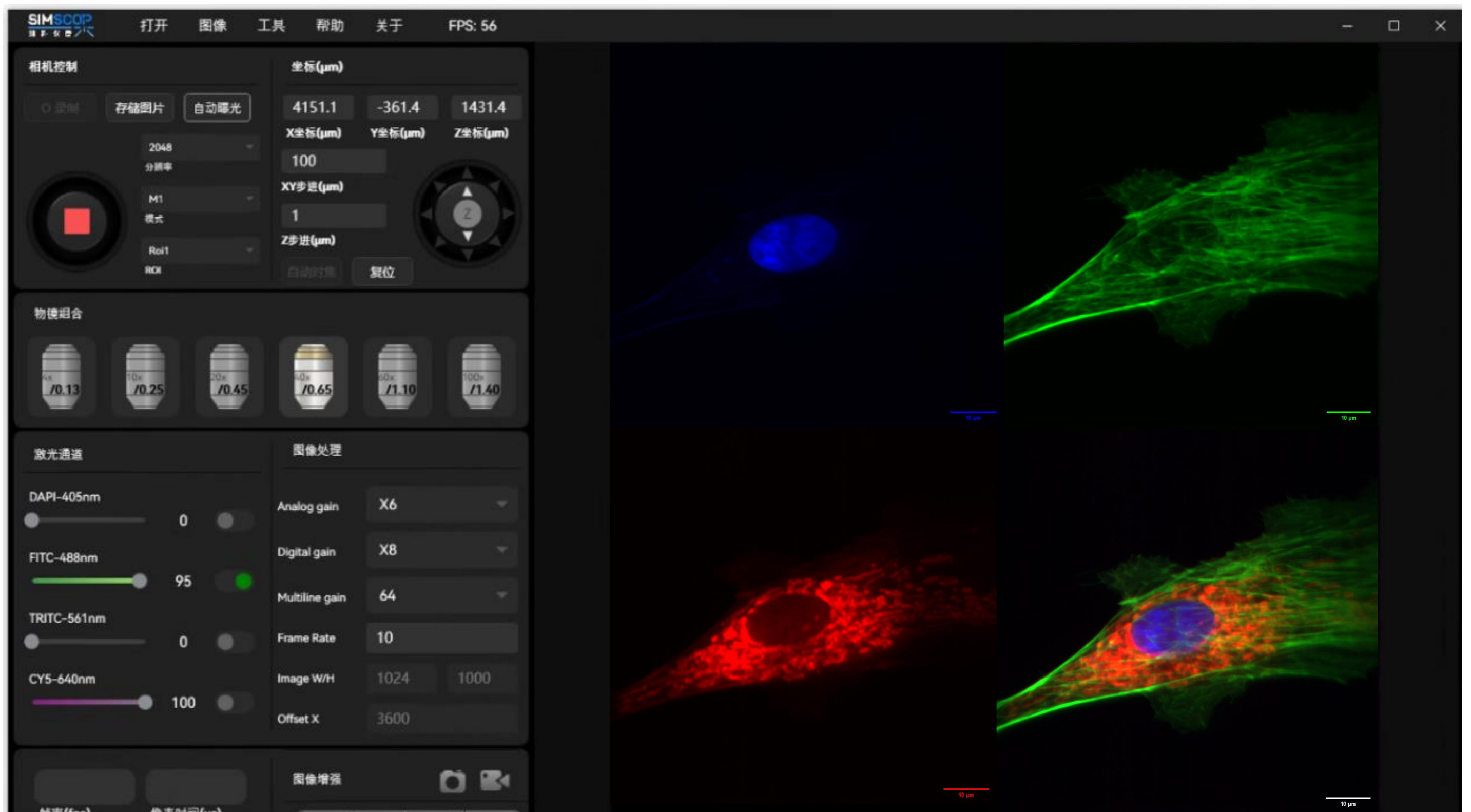

Functional GUI Panel

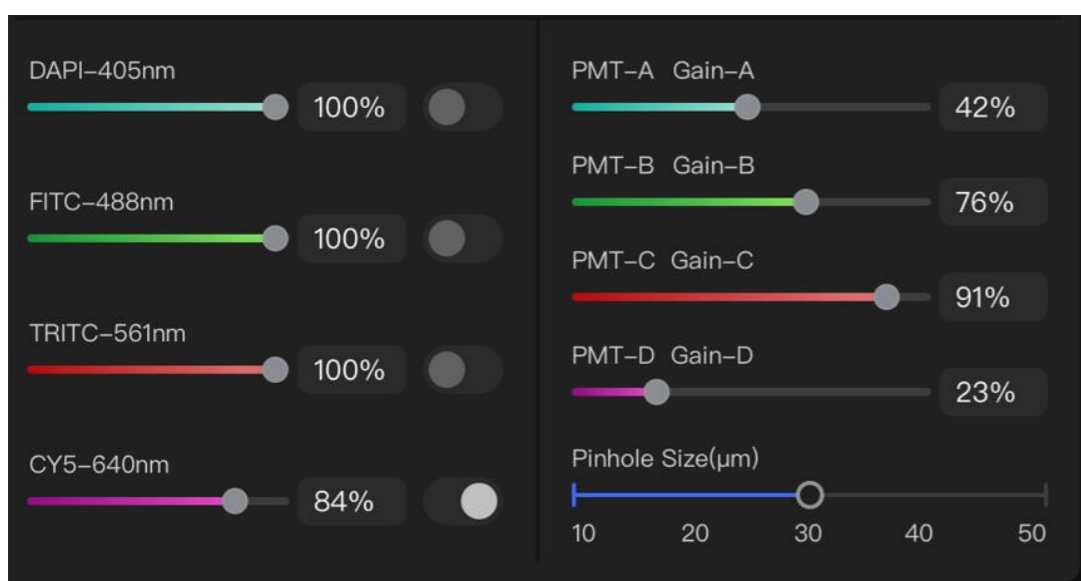

Easy-to-Recognize Display for Setting Lasers, Detectors, etc.



Scanning Parameter Settings of XYZ Motorized Stage

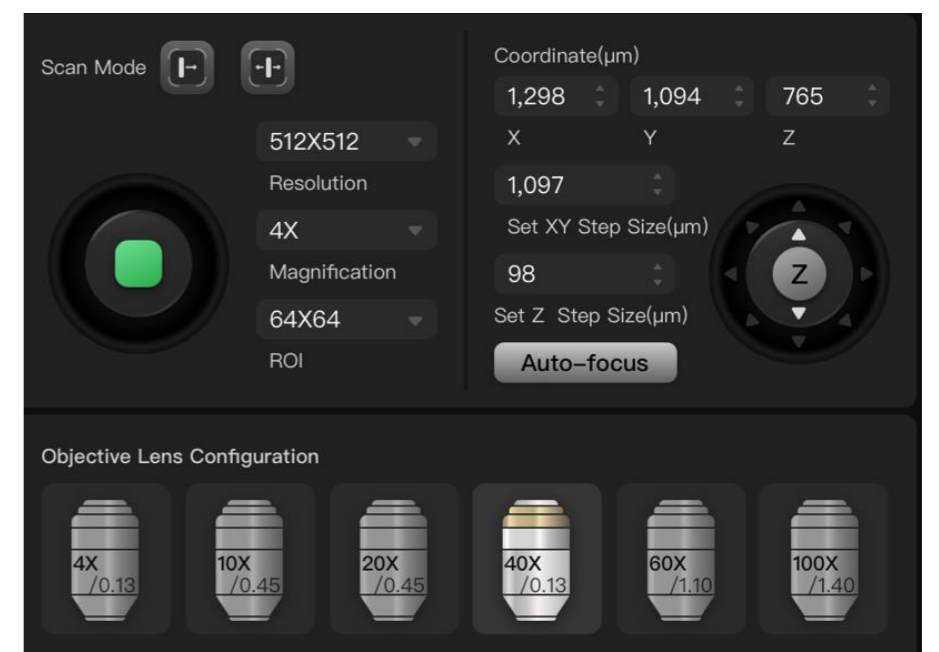

Parameter Settings of Microscope Image Acquisition

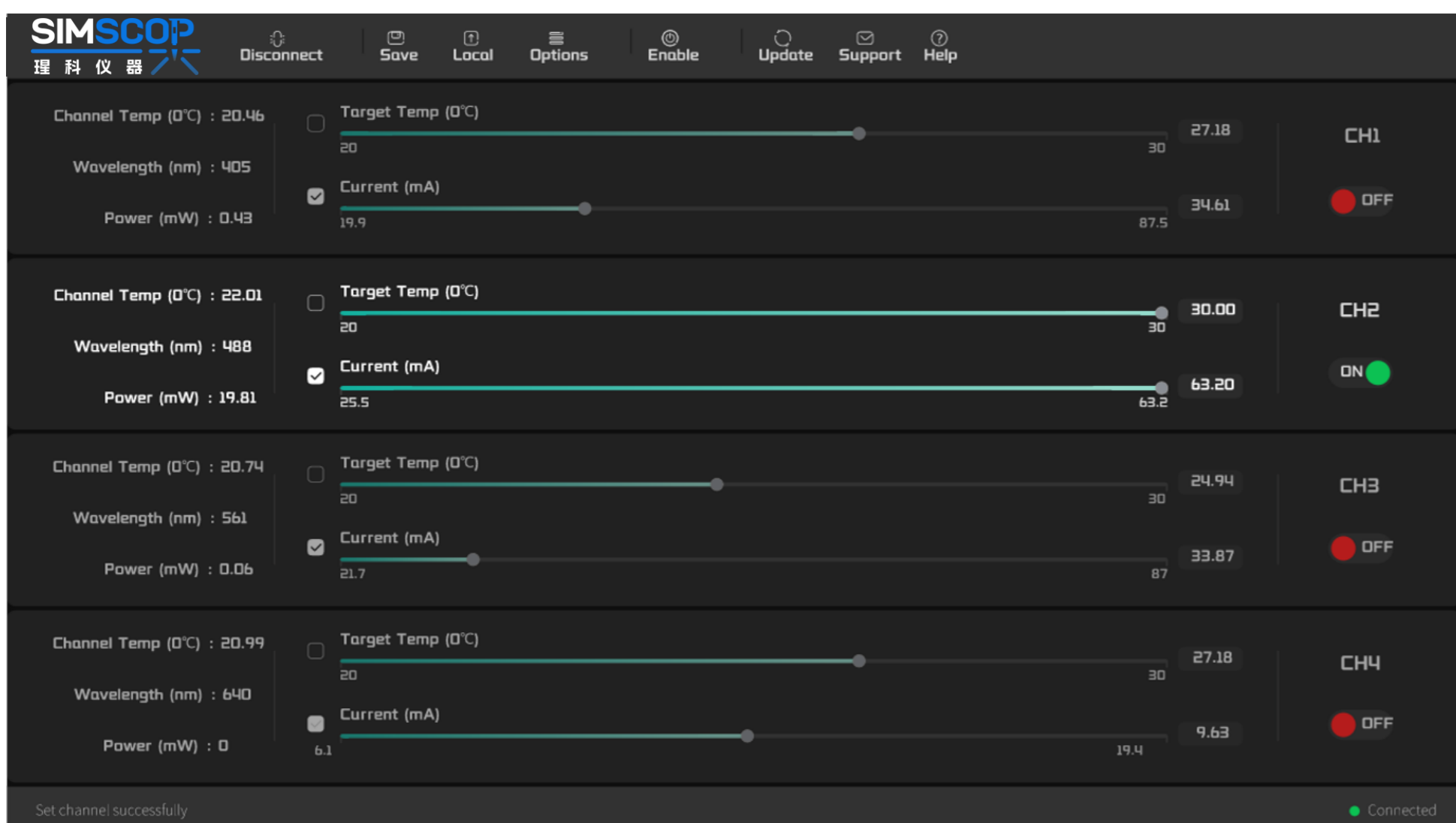

Laser Control Panel



Camera Parameter Setting

BPAE cells with MitoTracker™, Red CMXRos, Alexa Fluor™ 488 Phalloidin and DAPI, 60X objective lens

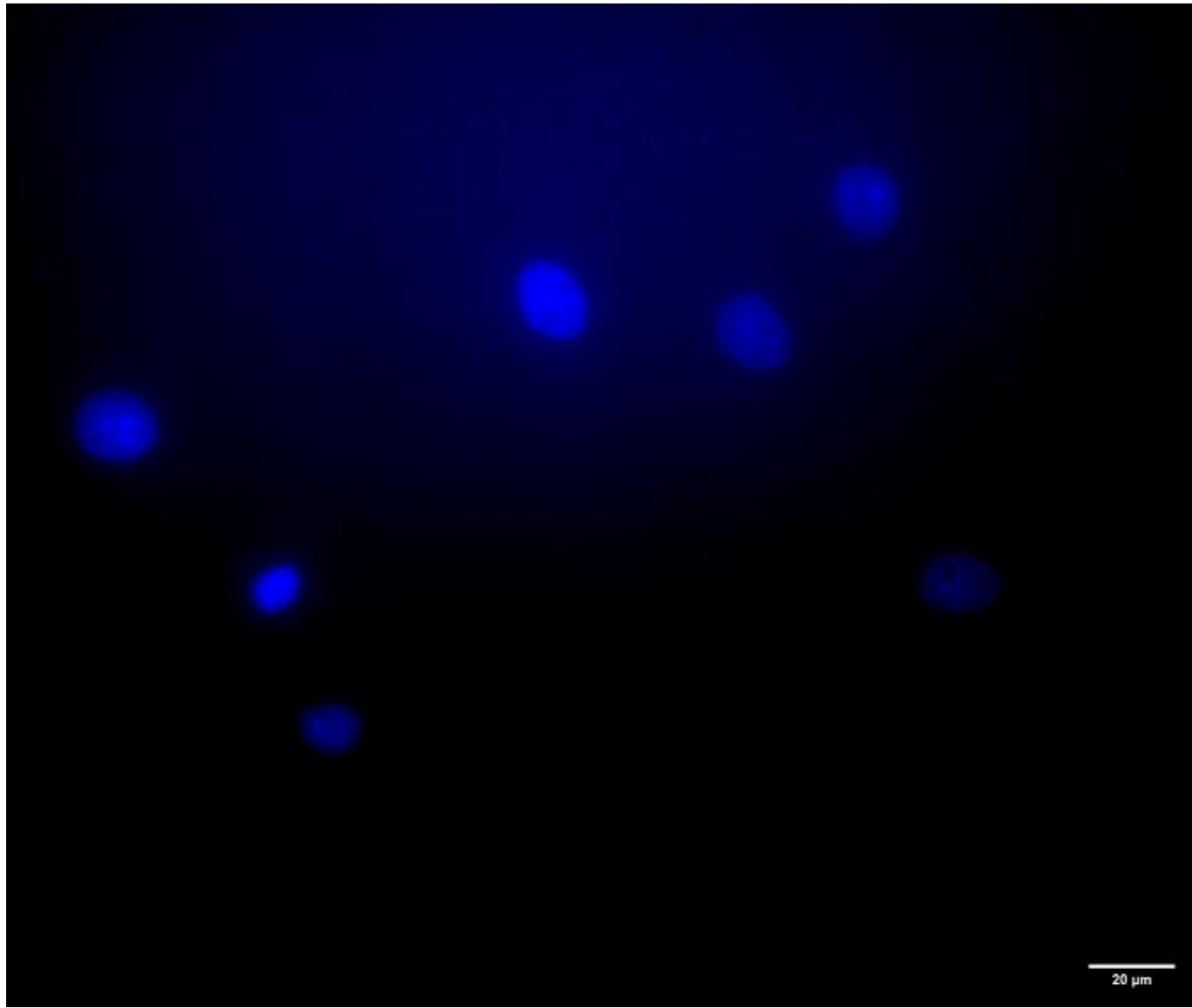

DAPI, 60X objective lens

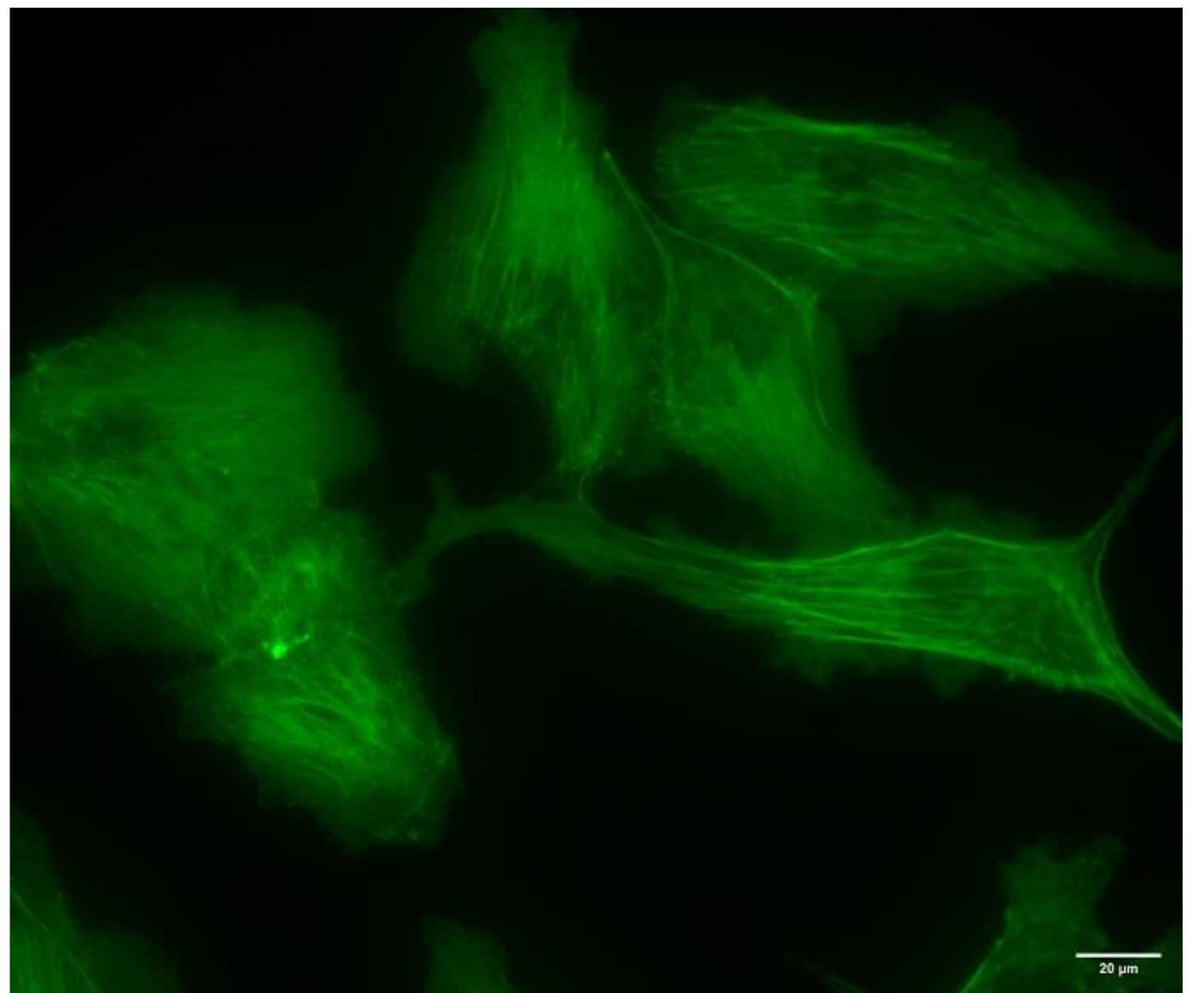

FITC, 60X objective lens

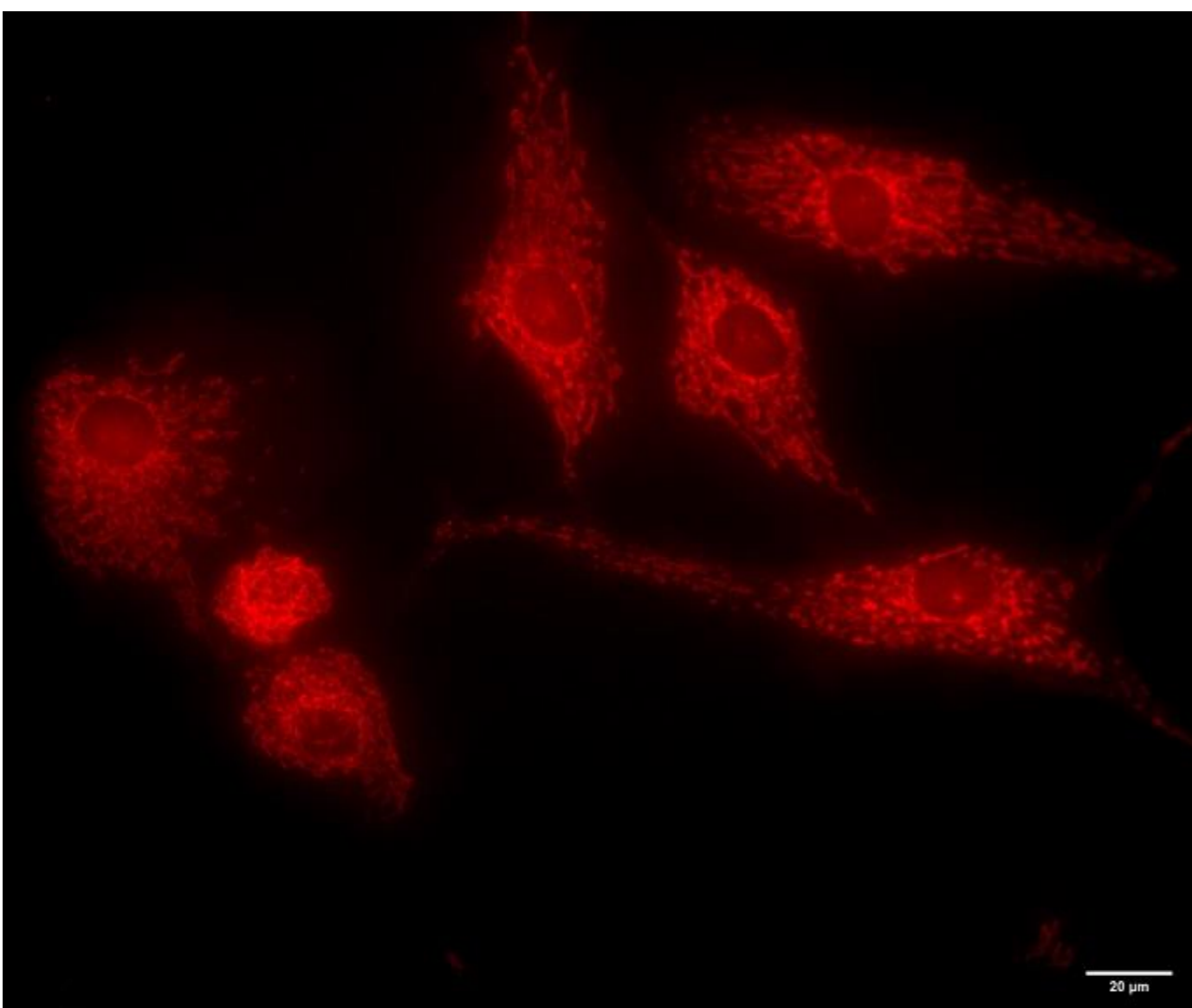

CY5, 60X objective lens

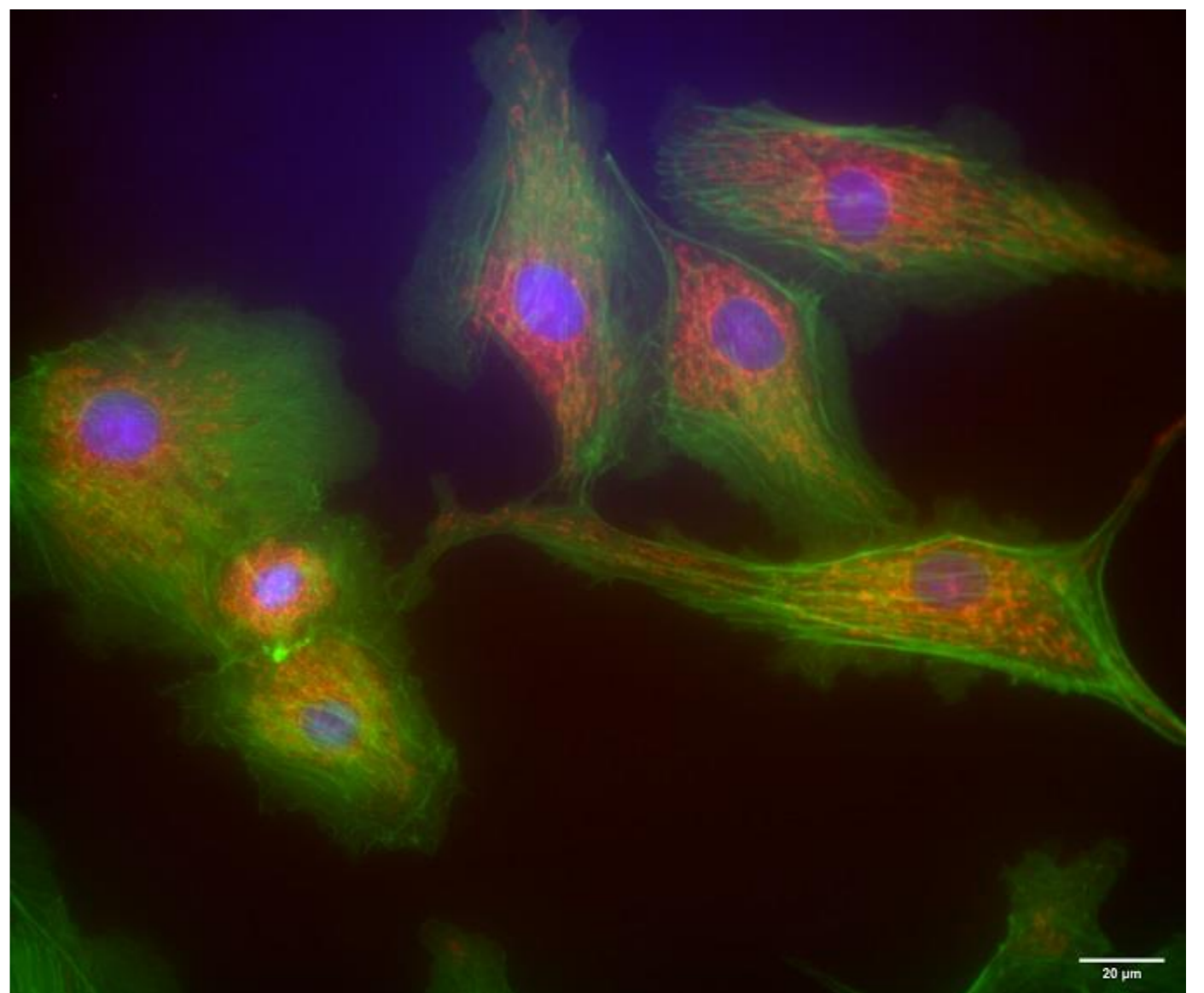

DAPI, FITC & Cy5, 60X objective lens

BPAE cells with MitoTracker™, Red CMXRos, Alexa Fluor™ 488 Phalloidin and DAPI, 100X

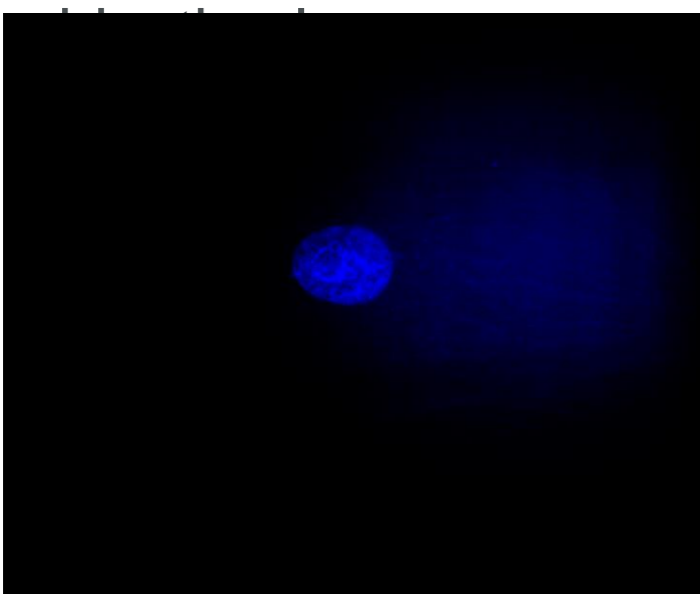

BPAE cells#1-100X-405

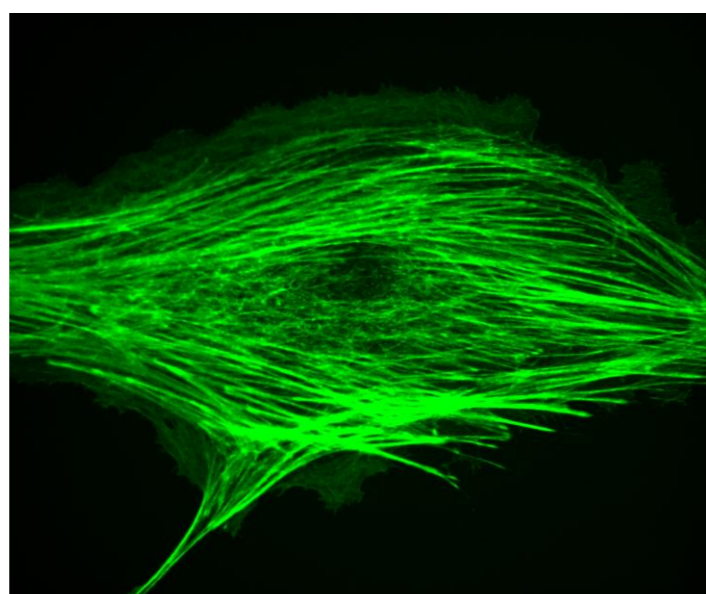

BPAE cells#1-100X-488

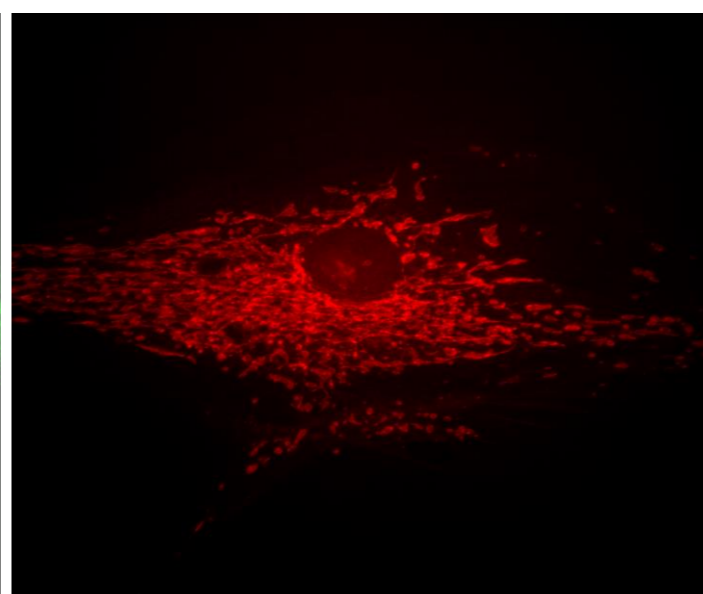

BPAE cells#1-100X-525

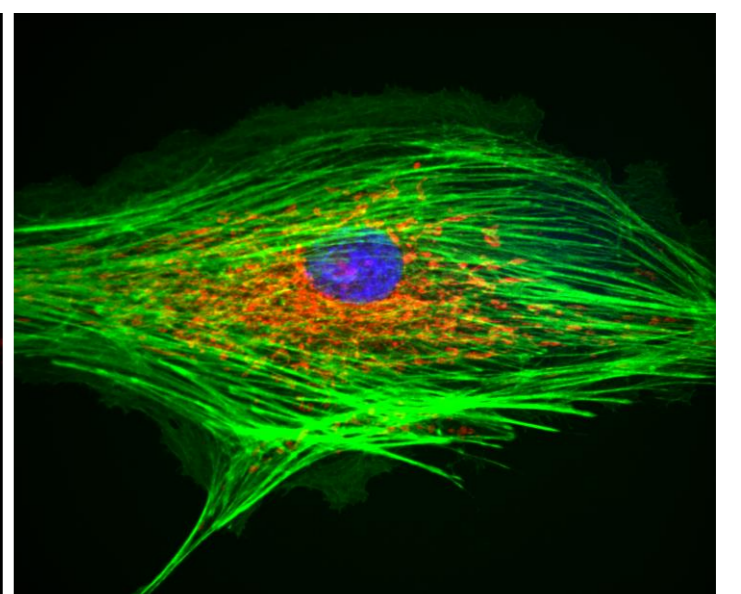

BPAE cells#1-100X-Composite

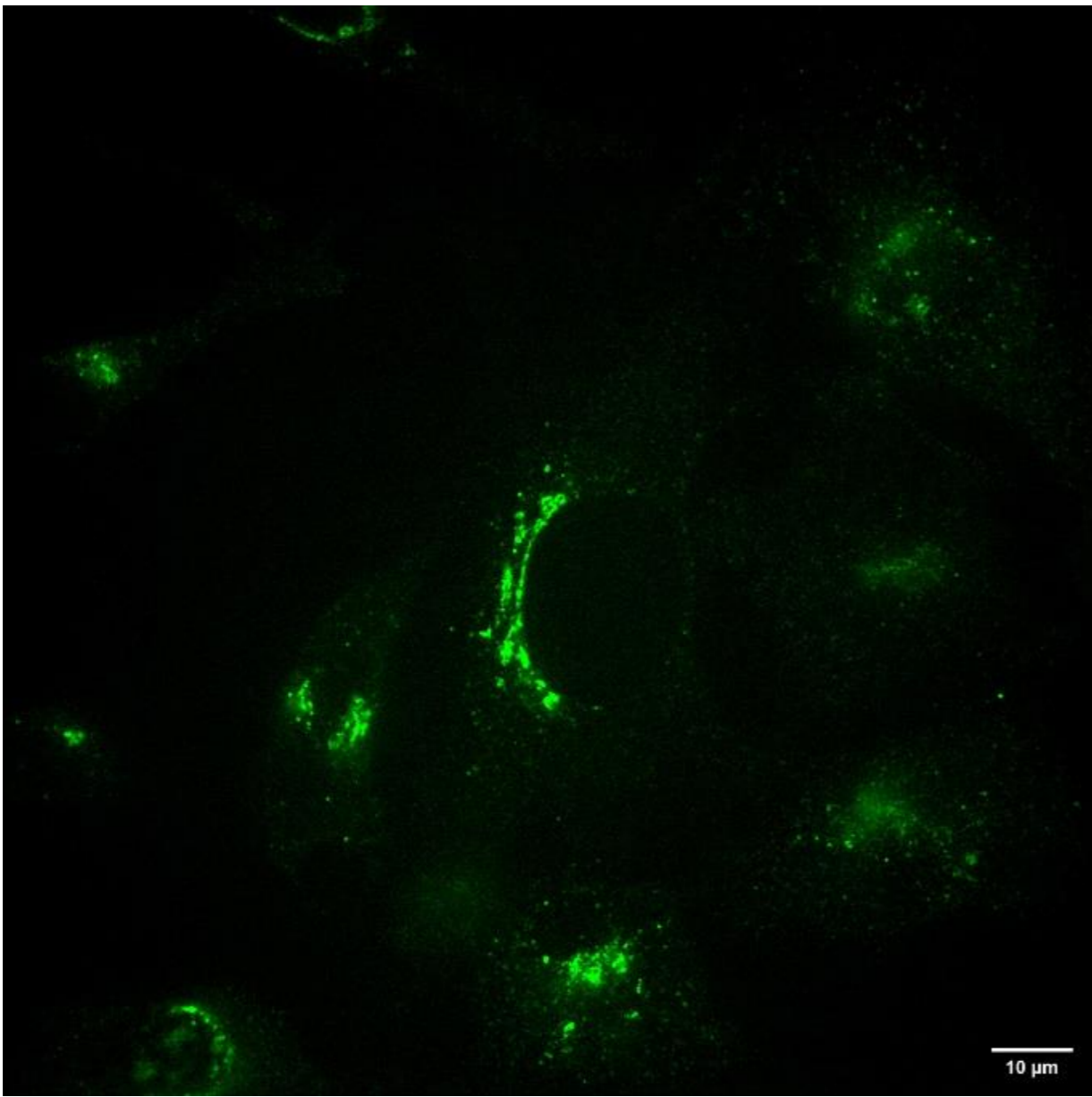

Cyto-Golgi scan, 100X objective lens

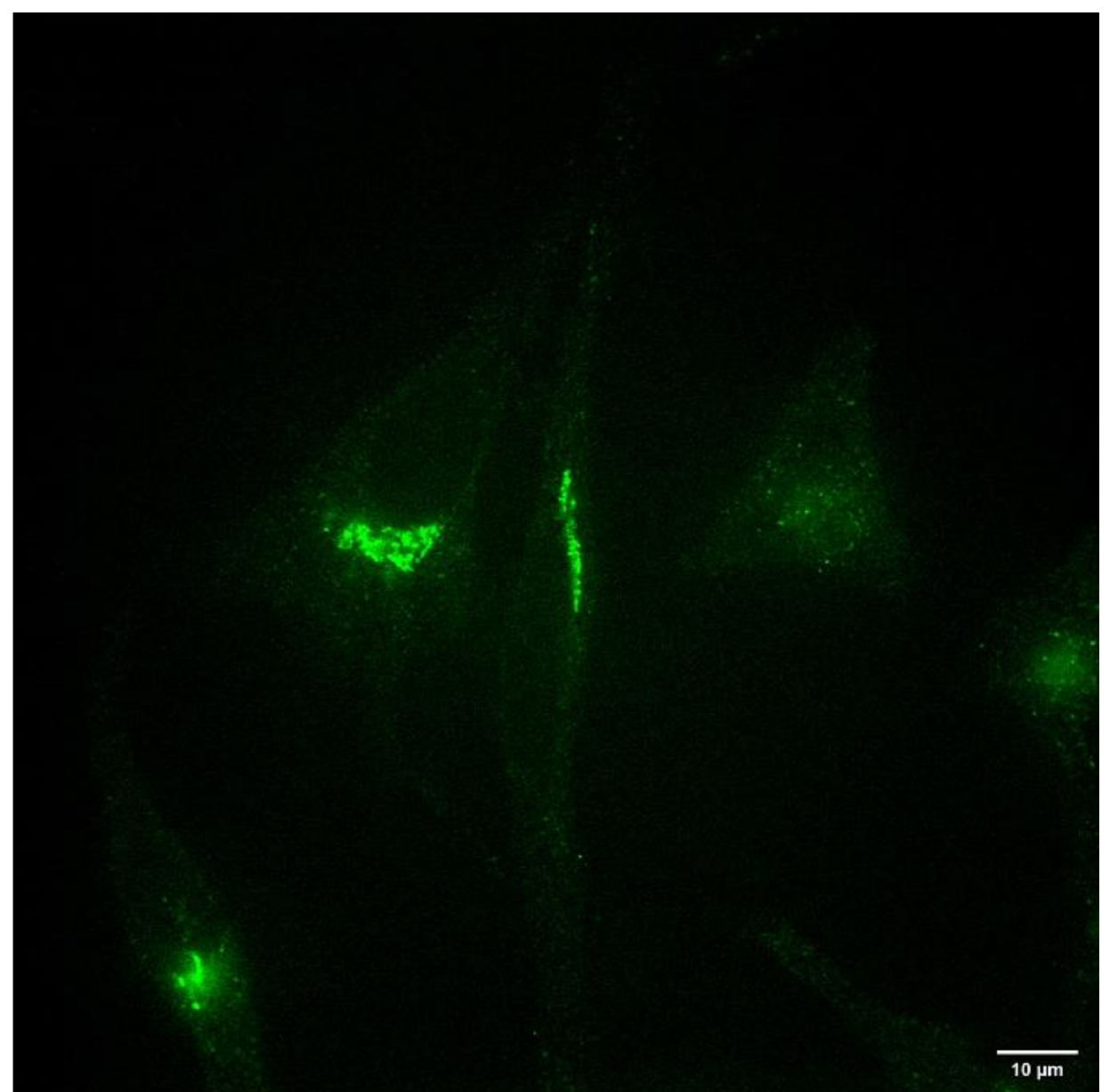

Cyto-Golgi scan, 100X objective lens

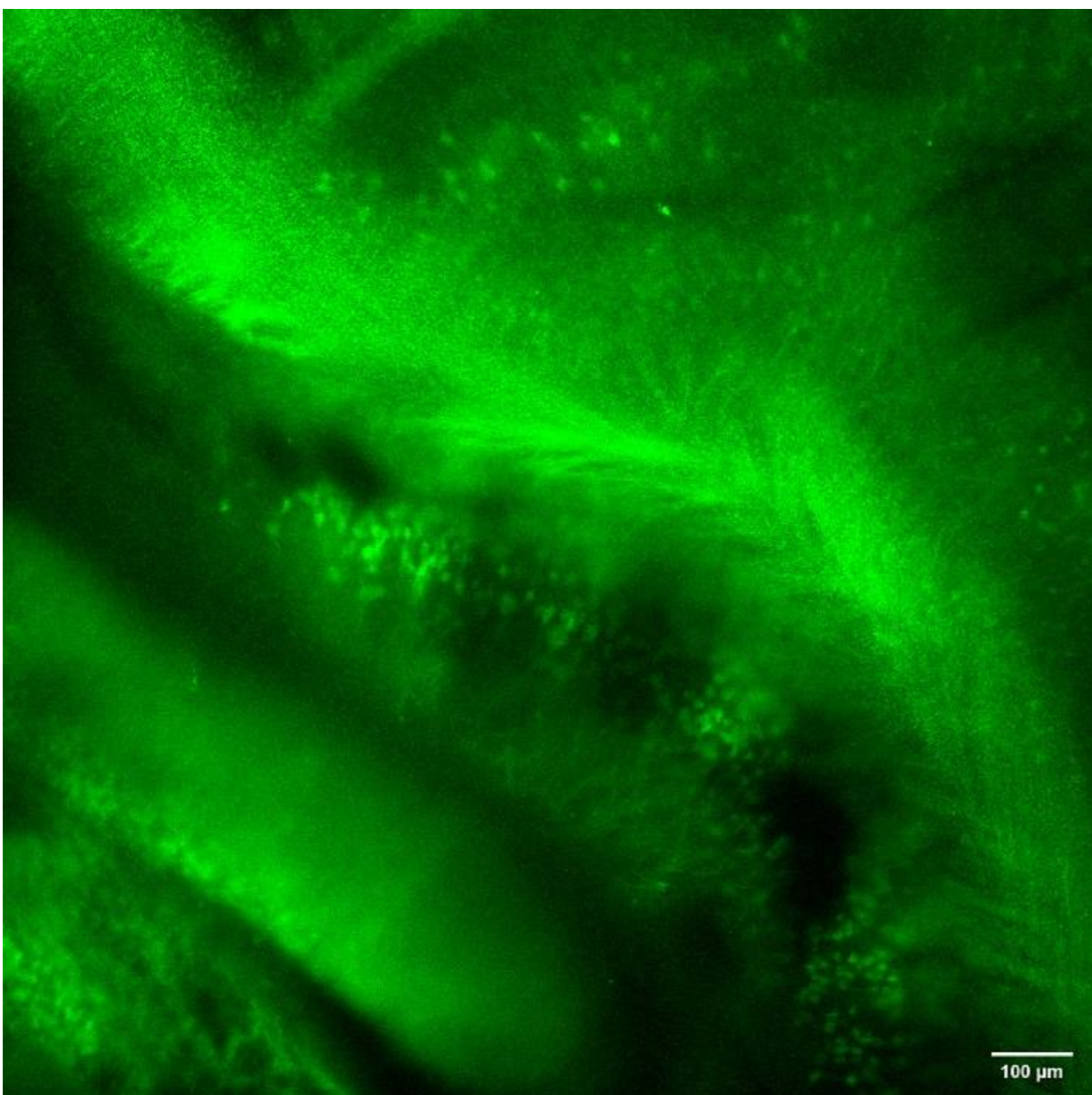

Mouse neural tomography, 10X objective lens,
wide field effect

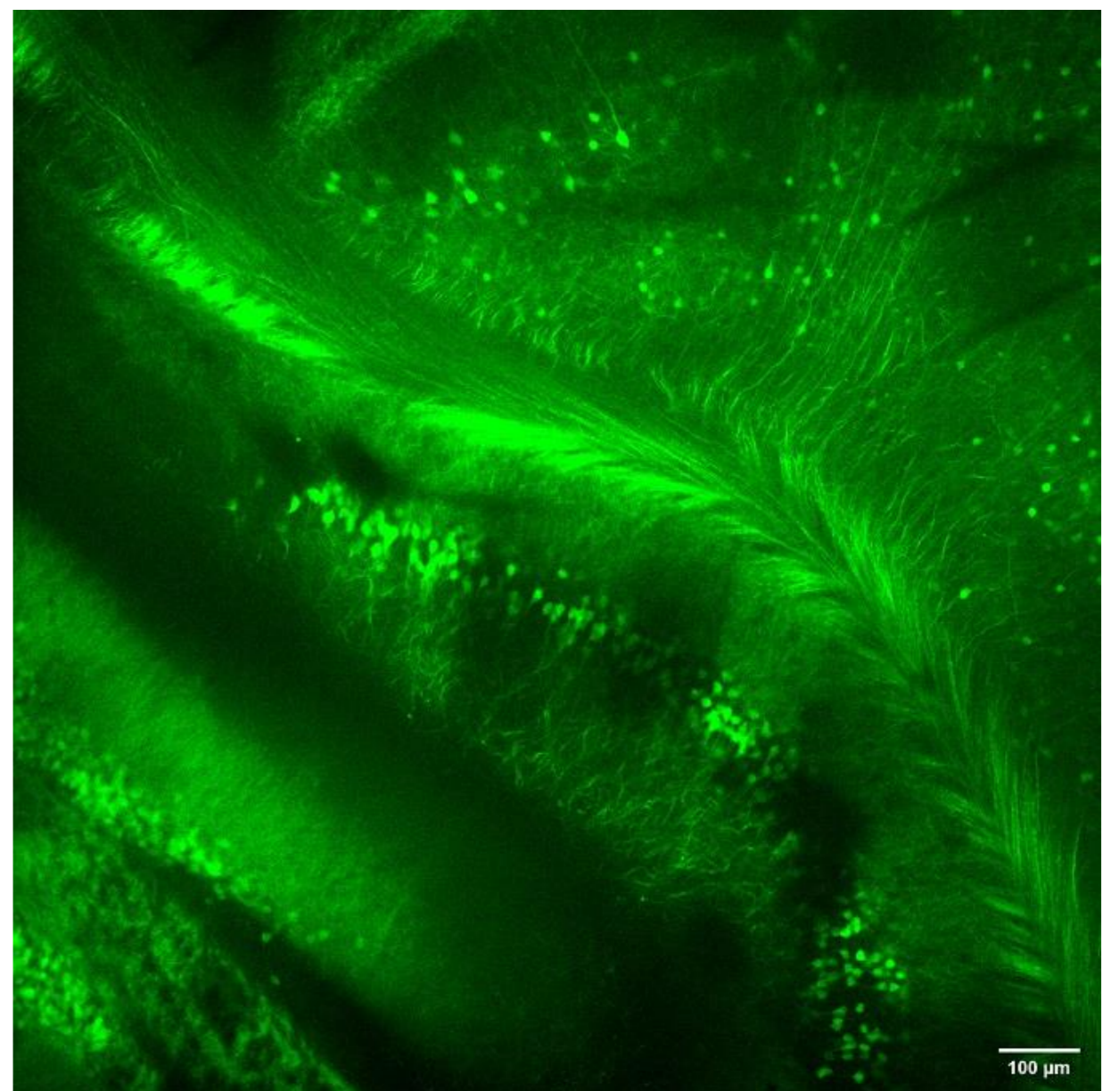

Mouse nerve tomography, 10X objective lens,
turntable effect

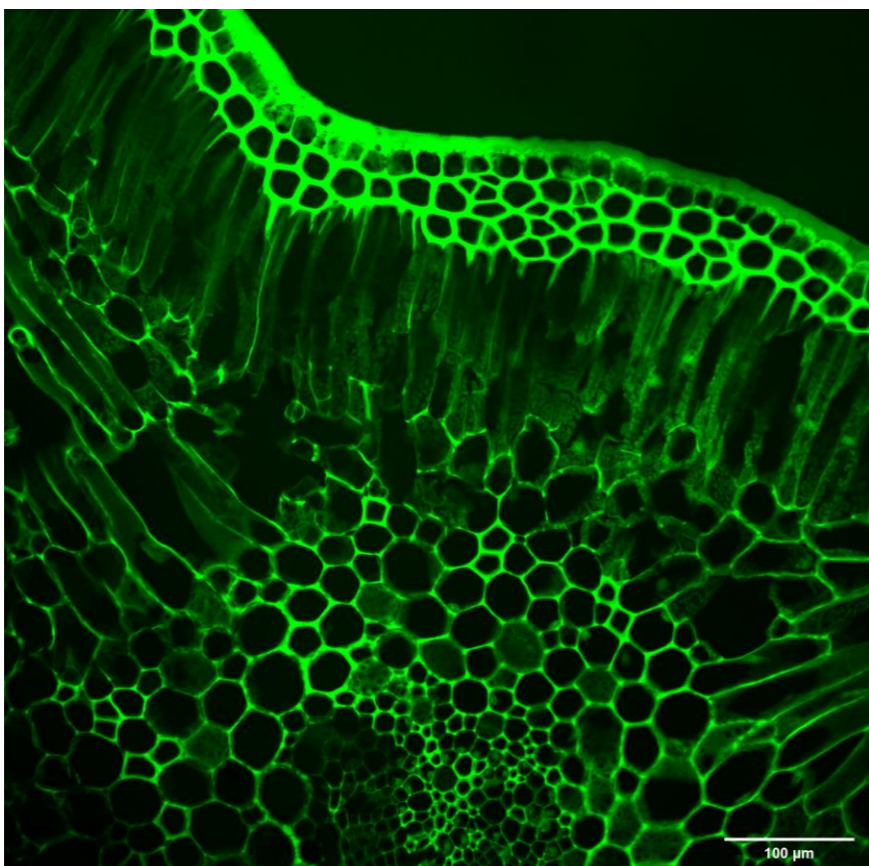

Sago palm leaf, 20X objective lens

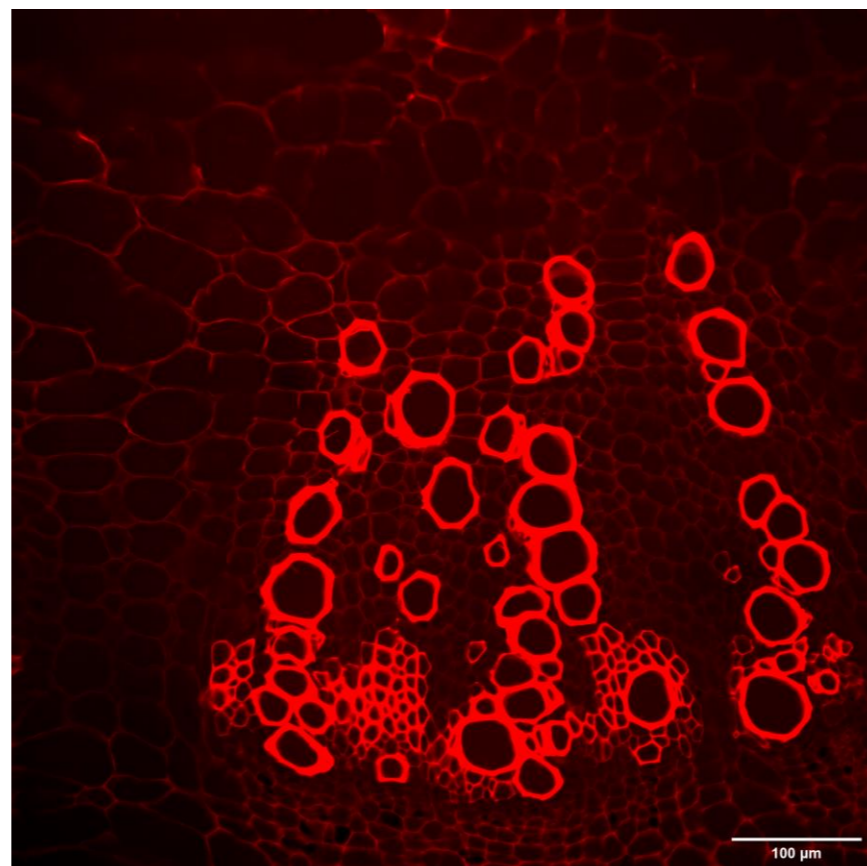

Spinach rhizome, 20X objective lens

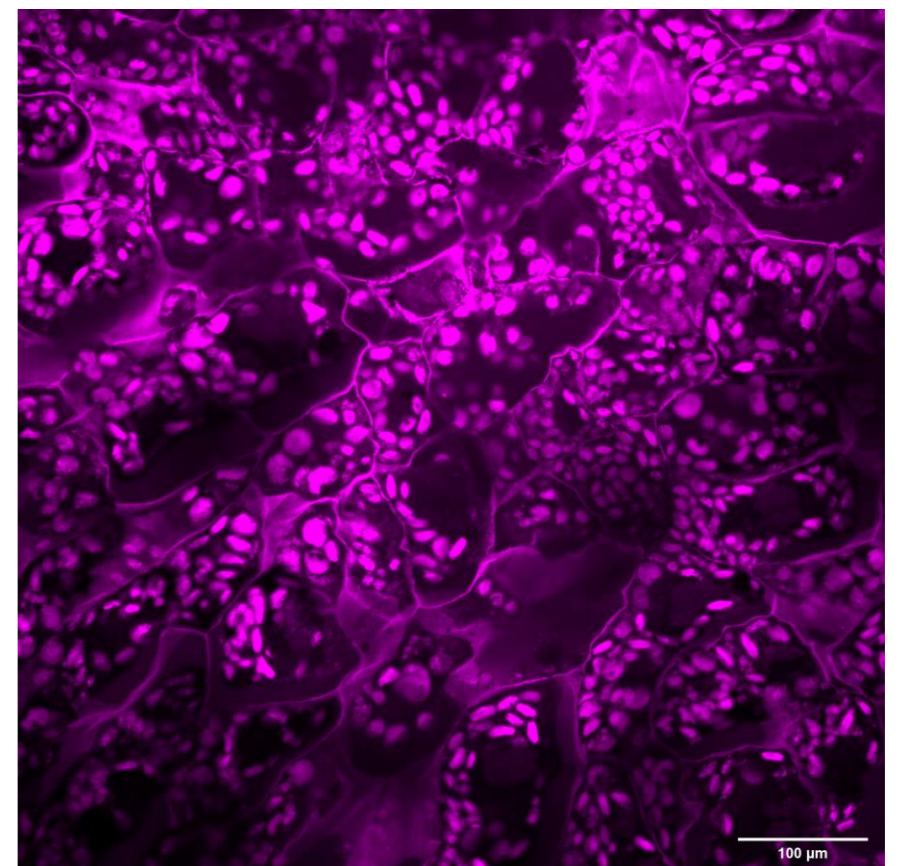

Wheat seeds, 20X objective lens

● Solution One : Confocal Spectral Microscope (Near-Infrared I/II Confocal)

- Upgrade to Confocal Spectral Microscope (NIR I/II confocal)
- Wavelength Range UV to NIR (200nm-2.5nm)
- Spectral resolution up to 0.2nm
- Large NA setup for high-sensitivity application

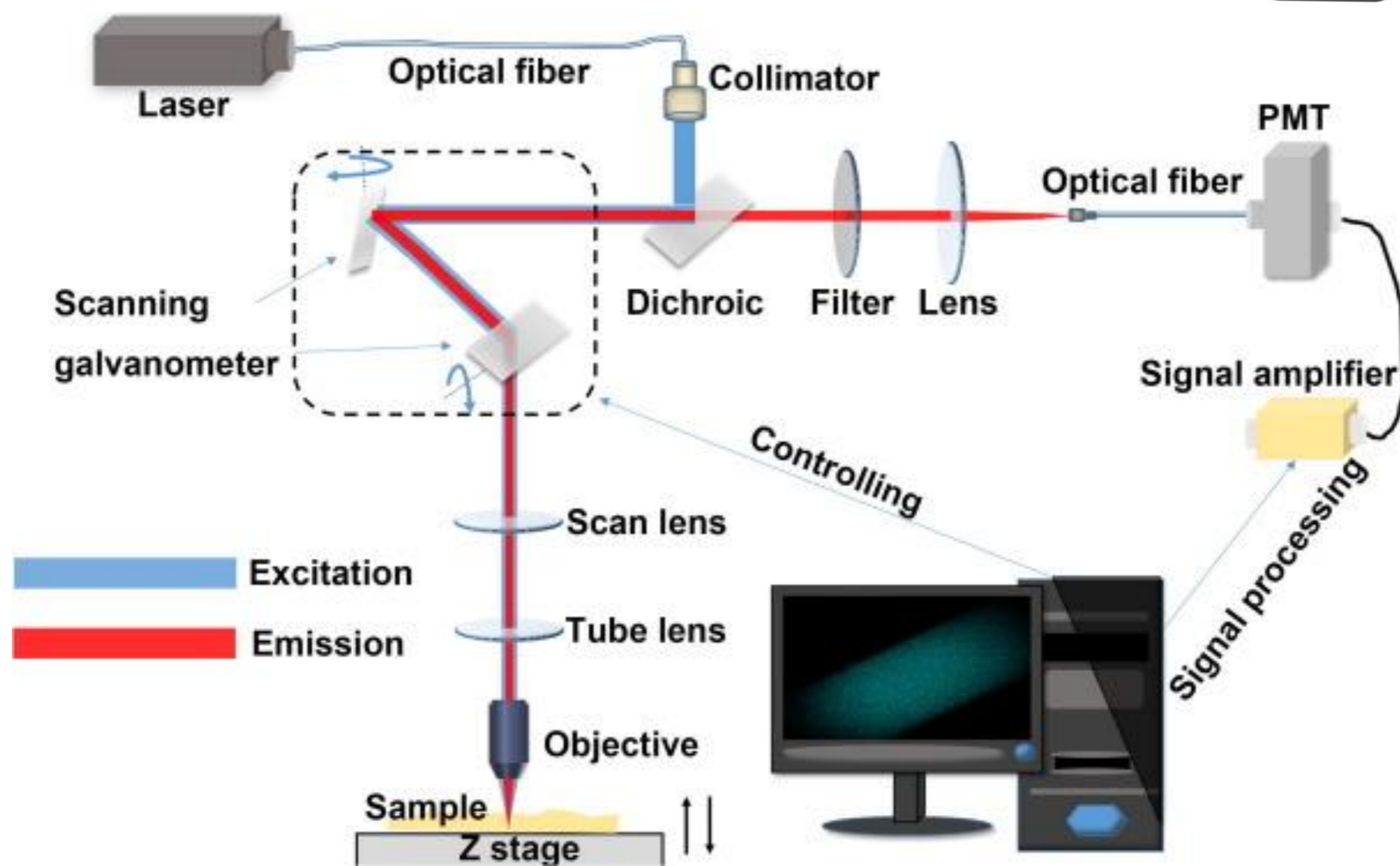

● Solution Two : Terahertz Confocal Microscope System

- 100GHz, output power: 80mW
- Spatial resolution 150-200um

The terahertz confocal microscope uses a focused beam of terahertz radiation to scan the sample being analyzed. This beam is then reflected back and collected by a detector, which creates an image of the sample based on the intensity of the reflected radiation. By using a confocal design, this microscope can achieve high resolution and can selectively focus on different depths within a sample.

It can be used to study the microstructure and properties of materials, such as polymers, ceramics, and semiconductors, and to detect defects or anomalies in their structures. In biology and medicine, it can be used to image and study biological tissues, including skin, teeth, and cartilage, which are transparent to terahertz radiation.

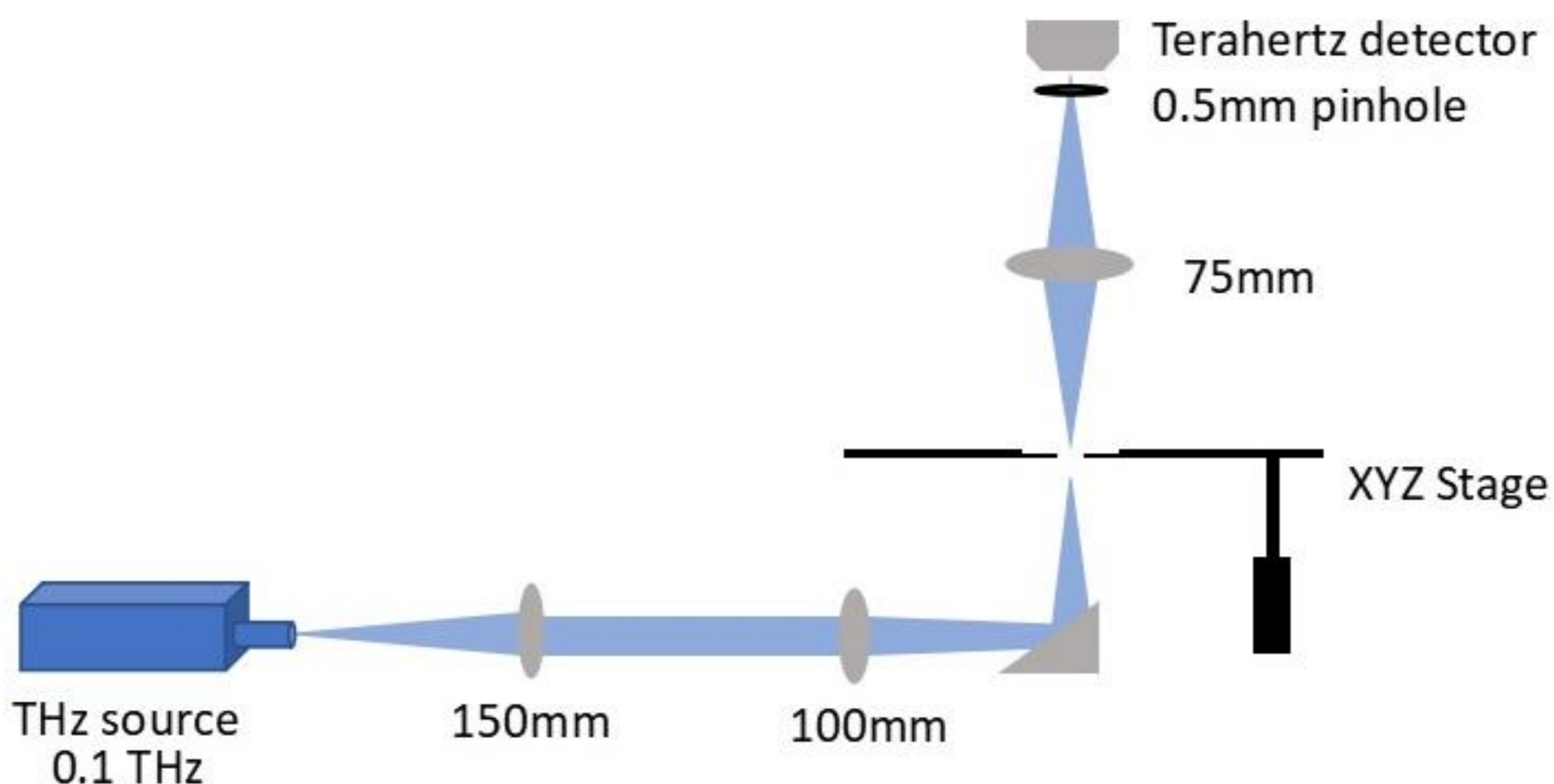

● Solution Three: Super Resolution Confocal Re-scan Structure Illumination Microscope

A "re-scan" confocal microscope is a type of confocal microscope that uses a rapidly moving mirror or scanner to scan across the sample multiple times, producing even higher resolution and better contrast images than standard confocal microscopes.

Overall, re-scan confocal microscopes are very powerful tools for studying biological tissues, cells, and other samples, and are widely used in research labs, medical facilities, and other scientific settings.

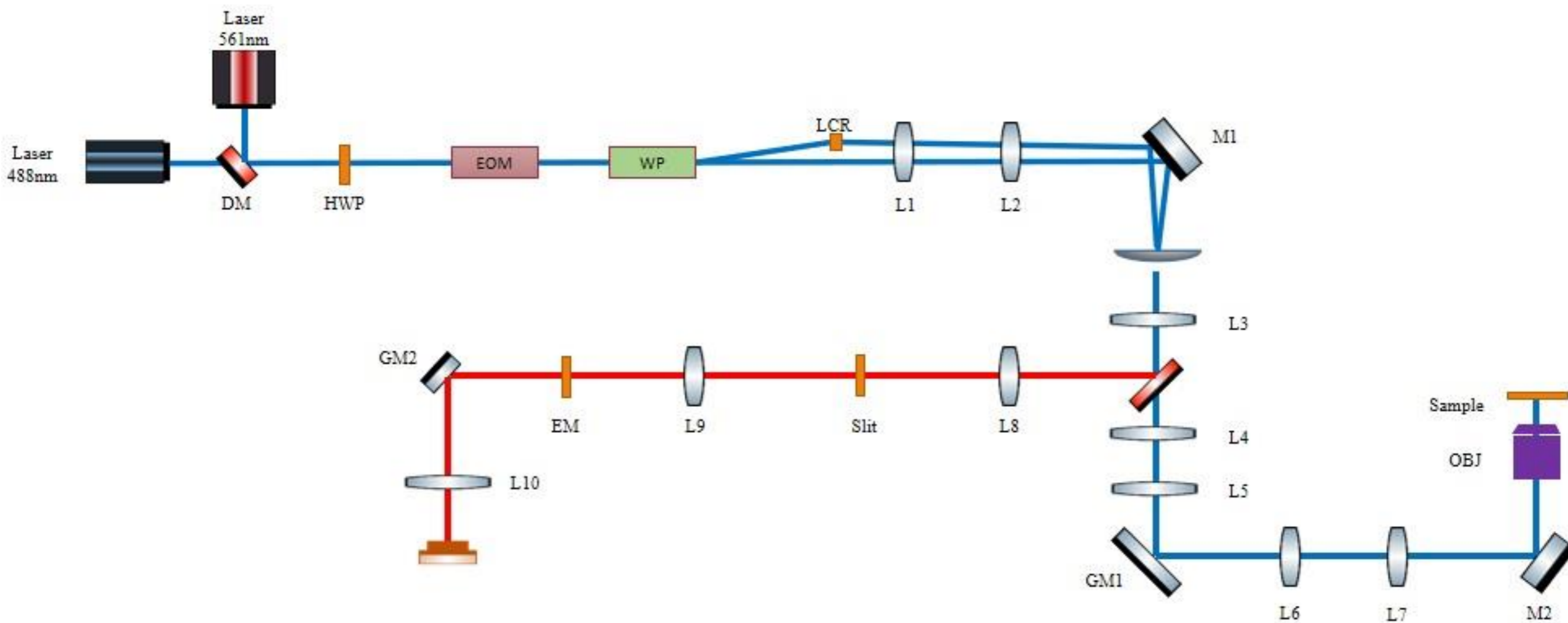

● Solution Four: Fluorescence Lifetime Imaging Microscopy (FLIM)

FLIM is a type of microscope that allows visualization and analysis of biological samples based on the fluorescence lifetime of the fluorophore being used. FLIM measures the time between the excitation and emission of photons in a sample, which can provide information about the properties of the fluorophore and the environment in which it is located.

FLIM can be used to study a wide range of biological processes, including protein-protein interactions, enzyme activity, and ion concentration changes. It is often used in combination with other imaging techniques, such as confocal microscopy, to provide more detailed information about the sample.

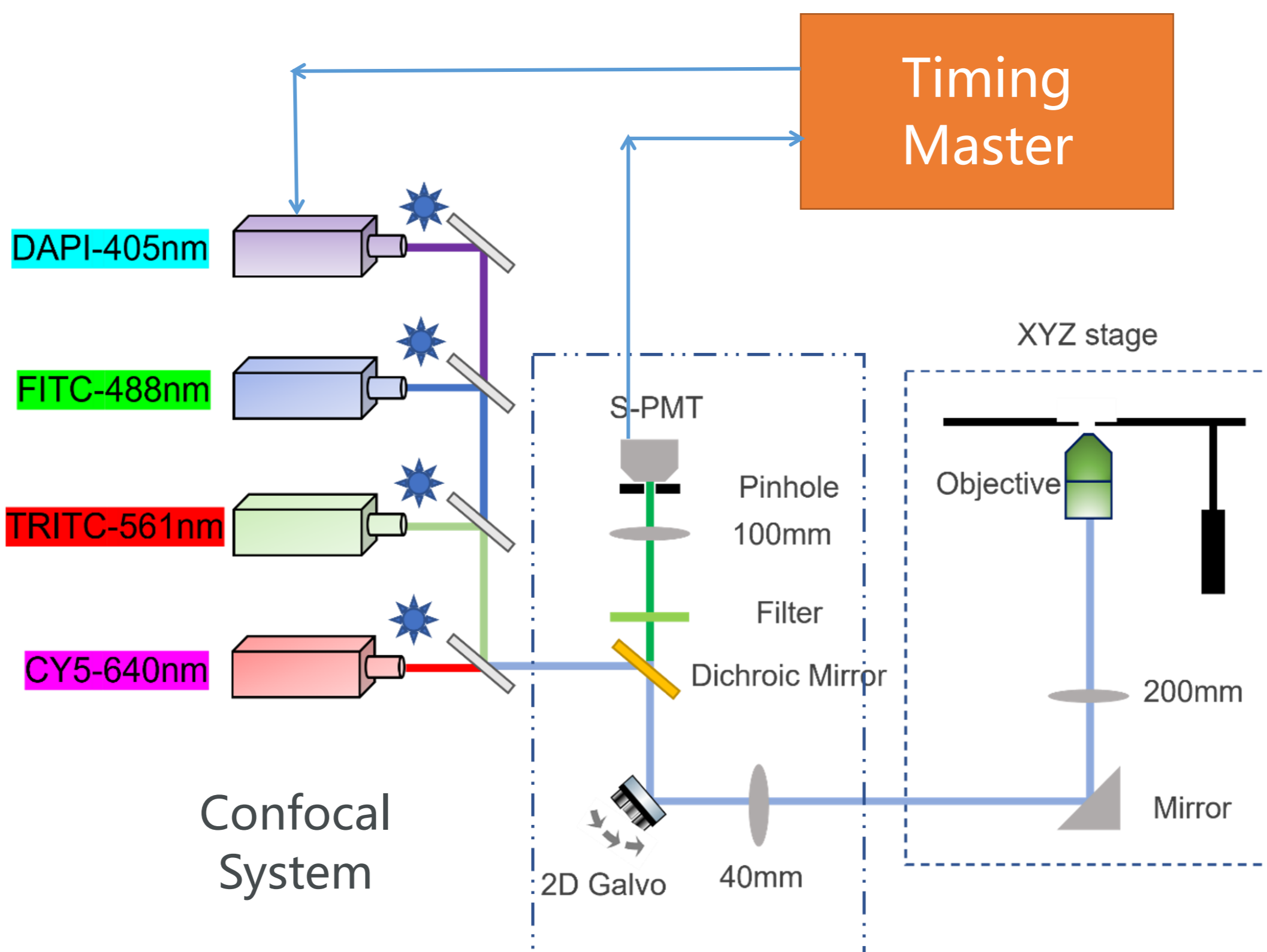

● Solution Five : Low Temperature Confocal Microscope

Compatible with SIMTRUM Cryostat to perform Low-temperature Raman measurements -190 to 600 degrees

- 8 probe arms able to upgrade to adjustable probe arm
- Reflection or transmission mode available

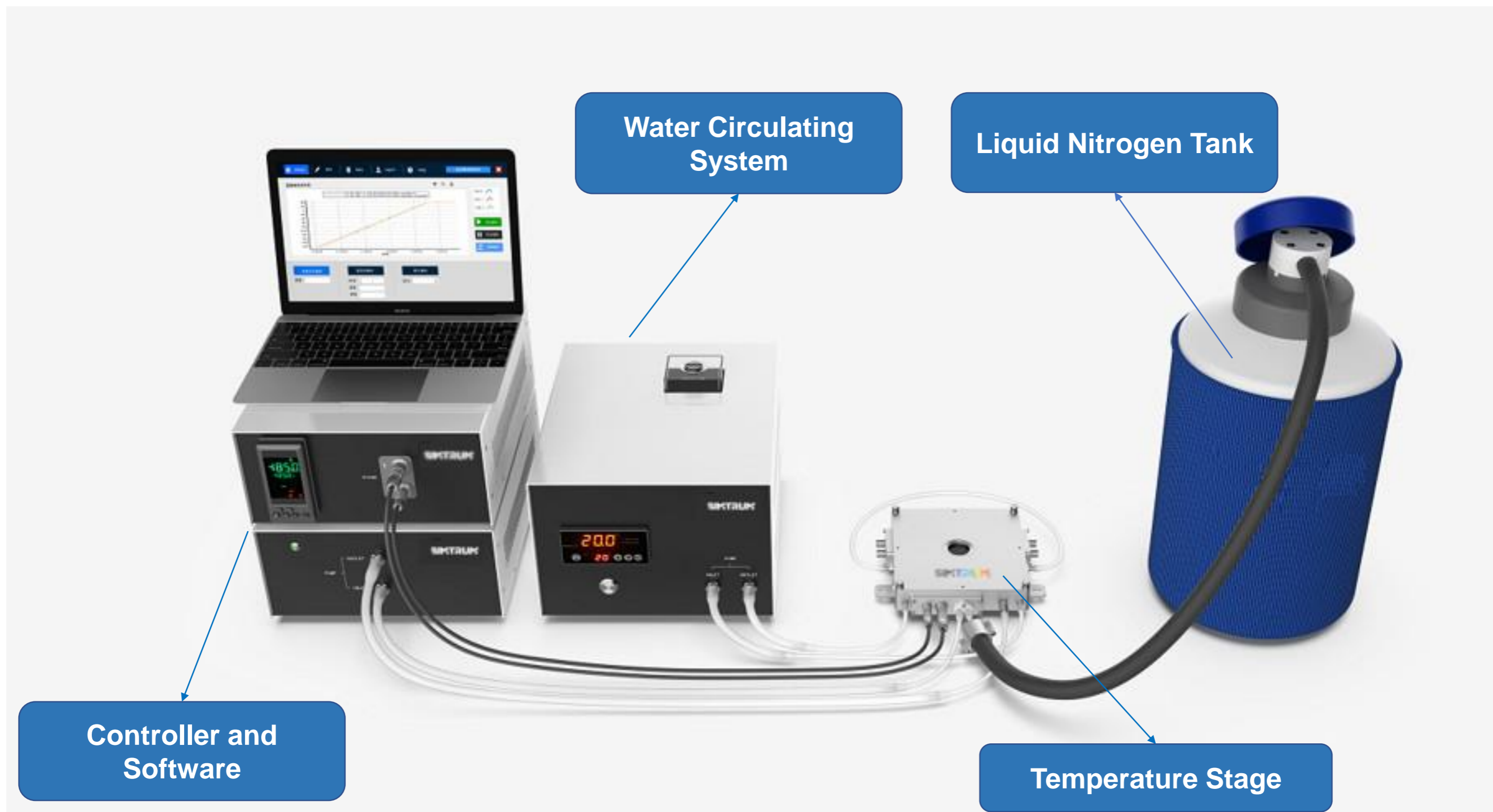

● Solution Six: Light Sheet Microscope

The working principle of LSM involves separating the illumination and detection paths into two orthogonal planes. The illumination plane is a thin sheet of light produced using a laser or LED light source and a cylindrical lens. This sheet of light then scans through the sample, illuminating only a thin slice of the sample at a time. The light emitted by the sample is then detected by a camera or photomultiplier tube positioned perpendicular to the illumination. It allows for rapid, high-resolution imaging of three-dimensional (3D) structures within living organisms while minimizing light damage.

LSM has a wide range of applications in biological research, including the study of embryonic development, neural circuits, and the response of cells and tissues to stimuli. They are also used for imaging of entire organisms, such as zebrafish embryos and fruit fly larvae, to gain deeper insights into their behavior.

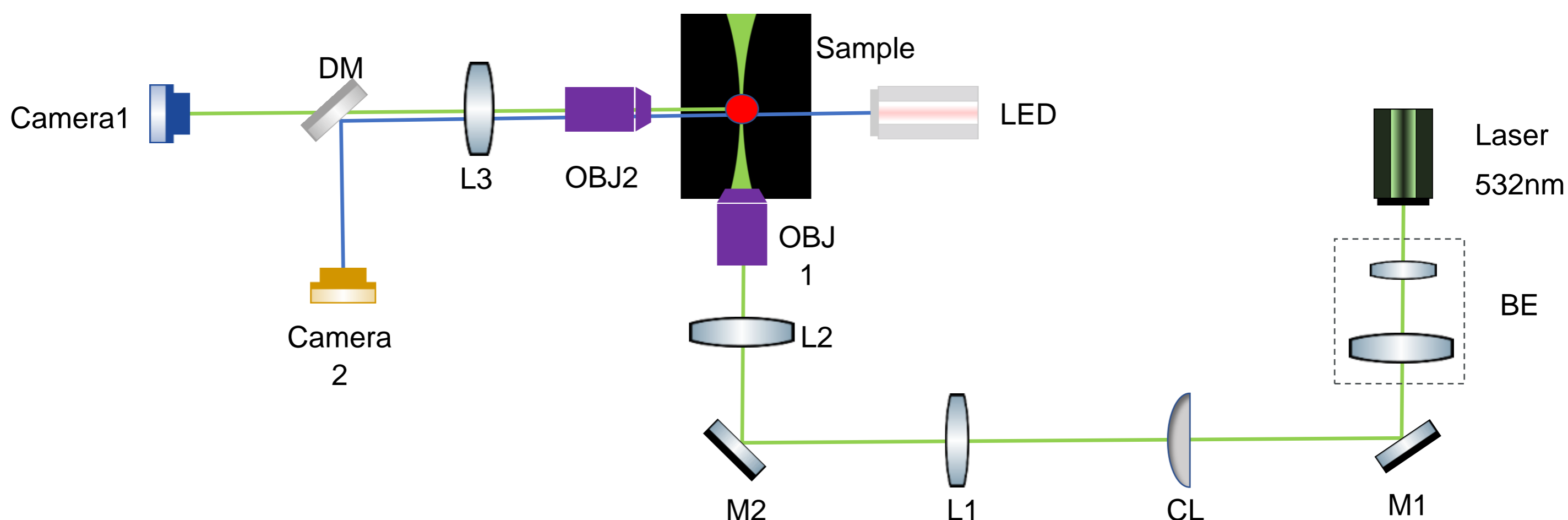
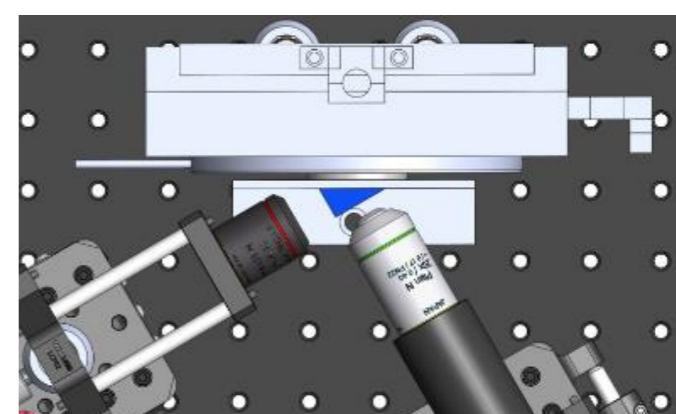

● Solution Seven : Single / Two /Multi Photon Microscope

In two-photon microscope, a laser emits light at a specific wavelength that is absorbed by the fluorescent molecules in the sample. When two photons of this light are absorbed simultaneously, they provide enough energy to excite the fluorescent molecule and cause it to emit light at a longer wavelength, which can be detected by the microscope. Because two photons are required to excite the molecule, the probability of fluorescence emission is low and only occurs at the focal point of the microscope, allowing for high-resolution imaging and greater depth than conventional microscopes.

Two-photon microscope has a number of applications in neuroscience, biology, and biomedical imaging. For example, it has been used to study the activity of individual neurons in the brain, to visualize the structure and function of blood vessels, and to track the behavior of cells in living tissues.

